

Operations Manual For Medfusion 2010i Syringe Pump

(Software Version 2.0)*

* Note: The software version on the pump may display a third digit that is consistent with a software update that does not affect the operation of the pump and is invisible to the user. Please call Medex if the first or second digit on the pump does not correspond to this manual.

This product is compliant with the requirements for Electromagnetic Compatibility (EN60601-1-2) per Council Directive 89/336/EEC. The CE mark is applied to this product when destined for Europe to indicate compliance.



11360 Technology Circle
Duluth, Georgia 30155
(770) 623-9809

P/N 9-61-2010i-0-1
REVISION 1
DECEMBER, 1996

2010i OPERATIONS MANUAL

TABLE OF CONTENTS

	Page
SECTION 1	INTRODUCTION 1-2
SECTION 2	GENERAL SPECIFICATIONS 3-4
SECTION 3	GENERAL DESCRIPTION/DIAGRAM 5-7
SECTION 4	OPERATING INSTRUCTIONS 8-15
SECTION 5	INFUSION MODES 16-41
	<i>BODY-WEIGHT MODE 17-23</i>
	<i>MASS MODE 24-29</i>
	<i>CONTINUOUS MODE 30-36</i>
	<i>VOLUME/TIME MODE 37-41</i>
SECTION 6	BOLUS 42
SECTION 7	CHANGE RATE 43
SECTION 8	PRIME 44
SECTION 9	STANDBY TIME 45-46
SECTION 10	ALARMS/ALERTS 47-53
SECTION 11	BATTERY POWER 54
SECTION 12	BATTERY VOLTAGE 55
SECTION 13	IV POLE CLAMP/ACCESSORIES 56-58
SECTION 14	PRECAUTIONS 59-61
SECTION 15	CLEANING 62
SECTION 16	SERVICE AND LIMITED WARRANTY 63-64
SECTION 17	CUSTOM PROGRAM MODE 65-67
SECTION 18	USER BANKS 68-75
APPENDIX 1	FLOW RATES 76
APPENDIX 2	DEFINITIONS 77-78
APPENDIX 3	USE OF THE B-D® LUER LOCK SYRINGE IN THE OPERATION MODE 79
APPENDIX 4	LOCKOUT 80
APPENDIX 5	PUMP I.D. 80

SECTION 1: Introduction

The Medfusion 2010i Syringe Pump offers flexibility for a variety of clinical needs, settings and applications. The pump may be utilized whenever meticulous low volume drug or fluid injections using a syringe are required in the hospital. All medications should be delivered in accordance with their approved drug labeling. The pumps may be field customized for specific applications. A choice of 15 modes of delivery are available as follows: Body Weight Mode ($\mu\text{g}/\text{kg}/\text{min}$, $\mu\text{g}/\text{kg}/\text{HR}$, $\text{MG}/\text{kg}/\text{min}$, $\text{MG}/\text{kg}/\text{HR}$), Mass Mode ($\mu\text{g}/\text{min}$, $\mu\text{g}/\text{HR}$, MG/min , MG/HR , mU/min , mU/HR , U/min , U/HR), Continuous Mode (ml/min , ml/HR) and Volume Over Time Mode (dose volume/delivery time). In addition, the pump has the capability to store up to 64 user regimens/protocols. A bolus may be programmed then changed or administered at any time prior to or during drug delivery. The Medfusion 2010i Syringe Pump can be programmed for four types of infusion. Each infusion mode is listed below and explained in “Section 5: Infusion Modes” of this manual.

IMPORTANT: Clinical discretion should guide the use of this syringe pump and associated disposables. Considerations should include, but not be limited to, the medication or fluid to be administered, its stability, its compatibility, and its pharmacologic response to environmental conditions. Consult with the syringe manufacturer, medical literature, drug package inserts and other available sources for additional information on syringe/medication interactions.



CAUTION

In consideration of how syringe pumps operate, clinicians should consider use of appropriate syringe, tubing, and in-line devices for the given application and the drug being infused. Certain factors enhance multiple characteristics of syringe pump infusion such as time to detect an occlusion, visual verification of volume delivered, continuity of flow, time to reach the set rate. Following are considerations requiring discretion by clinicians using syringe pumps. (Typically, this is most important with continuous injections of short half-life drugs.)

- a. Select the smallest syringe size appropriate for the intended application. Friction within the syringe (between the plunger rubber tip and the barrel) can affect the continuity of flow and the time required to attain the set infusion rate; the plunger tip expands and relaxes throughout the infusion, particularly with larger syringes at slower rates. The best case is to use smaller syringes at higher rates.
- b. Do not use a 60 cc syringe for rates of 2.0 cc/hour or less. Such use is generally not recommended when using a syringe pump.

Introduction

- c. Connect the syringe pump tubing at the closest point to the patient for more predictable and accurate delivery of the fluid.
- d. Use small internal diameter, high durometer (hardness) tubing and no in-line devices for best results at low rates.



CAUTION:

Federal (USA) law restricts this device to the sale by or on the order of a physician.



WARNING:

Carefully read the entire contents of this manual, including the "PRECAUTIONS SECTION", before attempting to use your Medfusion 2010i Syringe Pump, and verify that the SOFTWARE VERSION of the pump and manuals are in agreement.

The Model 2010i has four infusion modes: body-weight, mass mode, continuous and volume over time.

1. **Body Weight Mode** where mass units (e.g.: mg or mcg) are delivered per weight (e.g.: kg) per time (e.g.: minute or hour). Rates for this mode would be programmed in mg per kilogram per minute or per hour and mcg per kilogram per minute or hour.
2. **Mass Mode** where mass units (e.g.: mg, µg, mU, U) are delivered per time (e.g.: minutes or hours).
3. **Continuous Mode** where volume (e.g.: ml) is delivered per time (e.g.: minutes or hours). Rates for this example would be programmed in ml per hour or ml per minute.
4. **Volume Over Time Mode** where the total delivery volume in ml and the desired delivery time in hours and minutes are programmed individually.

SECTION 2: General Specifications

<p>Overall Size 4.5" wide x 3.0" high x 7.5" long</p>	<p>Power AC Adapter DC Internal rechargeable batteries</p>
<p>Weight 2.5 pounds</p>	<p>Recharge Time No longer than 16 hours with the pump turned off.</p>
<p>Accuracy +/- 3% excluding syringe variations</p>	<p>Battery Capacity At 25°C, a 16 hour charge will operate the pump for approximately 10 hours at 5.0 ml/hr with a 60 ml syringe.</p>
<p>Infusion Modes <i>(may be field customized)</i></p> <p><u>Body Weight Modes:</u> µg/kg/min µg/kg/HR MG/kg/min MG/kg/HR</p> <p><u>Mass Modes:</u> µg/min µg/HR MG/min MG/HR mU/min mU/HR U/min U/HR</p> <p><u>Continuous Mode:</u> ml/min ml/HR</p> <p><u>Volume Over Time Mode:</u> volume/time</p>	<p>Alarms/Alerts</p> <ul style="list-style-type: none"> •Near Empty (5 to 60 minutes) •Empty •Dose Volume Delivered •Bolus Complete •Bolus Delivery •Occlusion •System Malfunction •Low Battery •Depleted Battery •Syringe Pops Out •Invalid Size •Invalid Number •Check Clutch •Alarm Temporary Delay: 2 or 60 minutes •Alarm Audio Volume: Soft or Loud •Load Syringe Plunger
<p>Flow Rate 0.01 to 378.0 ml/HR dependent on syringe size selected (See Appendix 1)</p>	<p>Status Alerts (Visual, Non Audible)</p> <ul style="list-style-type: none"> •Stop/Program •Deliver •Battery In Use •Battery Charging •Battery Depleted •Priming •Standby Mode •Back Light
<p>Bolus Delivery In Body Weight, Mass and Continuous Modes</p>	

SECTION 2: GENERAL SPECIFICATIONS CONTINUED...

Total Delivered

- from 0.0000 to 9999.9999 MG
 - from 0.00 to 9999.99 ml
 - from 0.0000 to 9999.9999 U
-

Syringe Options/Sizes

- Becton-Dickinson (B-D*): 1,3,5,10,20,30,60 ml
- Monoject* (Mono): 1,3,6,12,20,35,60 ml
- Terumo (Teru): 1,3,5,10,20,30,60 ml
- Becton-Dickinson Glass(BD-G): 1,3,5,10 ml
- Abboject* (Abot): 50 ml

** The following are trademarks: B-D (by Becton Dickinson and Company), Monoject (by Sherwood Medical), and Abboject (by Abbott Laboratories).*

Please note the following:

- Automatically senses syringe size (except B-D® 1cc Luer Lock Syringe, See Appendix 3).
- All syringes will fill to their maximum stated volume.

SECTION 3: General Description/ Diagram

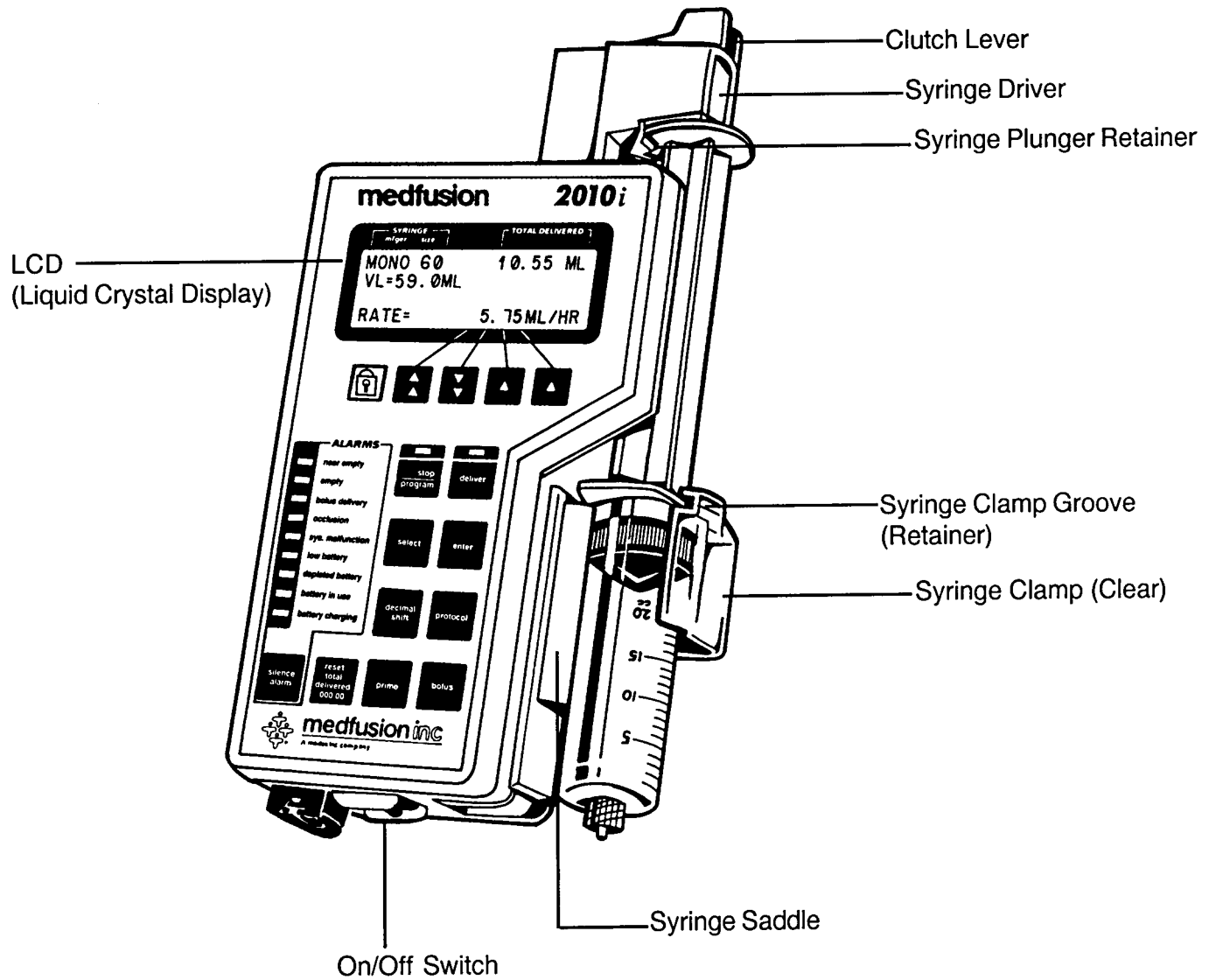

SECTION 3: GENERAL DESCRIPTION/DIAGRAM CONTINUED...

Rate Keys



These keys will move in increments of 50 counts regardless of decimal point location.

Press both simultaneously during stop to zero all numbers.

Rate Keys



These keys will move in increments of 1 count regardless of decimal point location.

Press both simultaneously to zero all numbers.

NOTE: *Holding down any rate key continuously will cause it to move faster than a single key press.*

Protocol



Used to scroll through different screens of user ID's and modes.

Used in conjunction with stop key to access Data Bank.

Used prior to operation to access User Bank "A".

Decimal Shift



Allows user to shift decimal point for concentration, bolus and dose in certain modes.

Stop/
Program



Used to stop infusion or bolus delivery.

Used in conjunction with protocol key to access user bank.

Deliver



Used to start delivery or initiate bolus.

Used to stop bolus delivery.

Select



Used to simplify screen by removing the displays for Weight and Concentration in Body Weight Mode or Mass Mode.

Used to select choices (i.e., acts as "NO" answer for certain selections or to toggle between "YES" and "NO").

Enter



Used to enter or confirm selections.

Used to temporarily display in ml/hour instead of weight or mass.

SECTION 3: GENERAL DESCRIPTION/DIAGRAM CONTINUED...

Silence Alarm



Allows audio silencing of alarm for 2 to 60 minutes.
(depending on what was programmed in Custom Programming)

Reset Total Delivered



Allows user to reset total volume to zero in stop mode.
Allows user to reset total volume to zero when concentration changed or ID changed.

Bolus



Allows for programming of bolus during stop or delivery.
Allows for delivery of bolus when used in conjunction with deliver key.

Prime



Used to purge fluid through line and to remove mechanical slack.

Used as a "clear" function to clear user name in the Data Banks.

Lockout



Used to lock pump so that settings cannot be changed.
Allows for stopping and starting only.

Pump Power Switch



Used to turn the pump ON and OFF.

SECTION 4: Operating Instructions

STEP 1: SYRINGE LOADING

STEP 1A:

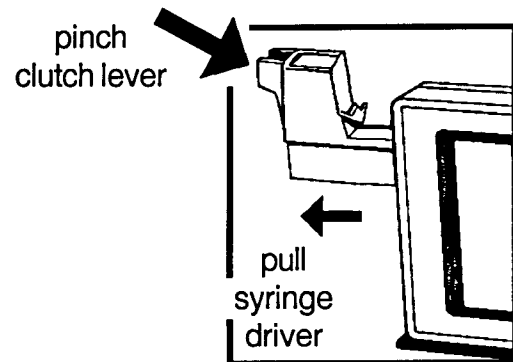

Pinch and hold together the CLUTCH LEVER (releases the clutch) and pull the SYRINGE DRIVER outward until it reaches the end of its track.

STEP 1B:

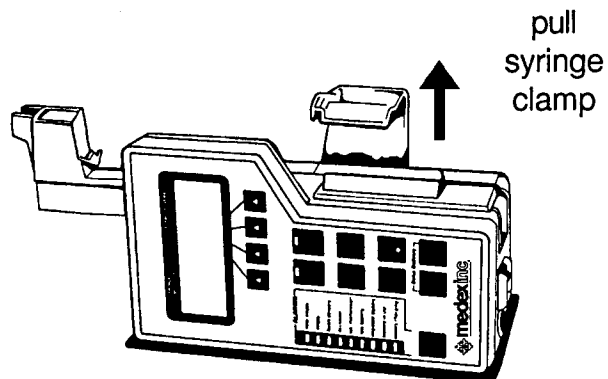

Grasp the clear SYRINGE CLAMP, pull upward allowing room for the syringe in the SYRINGE SADDLE.

STEP 1C:

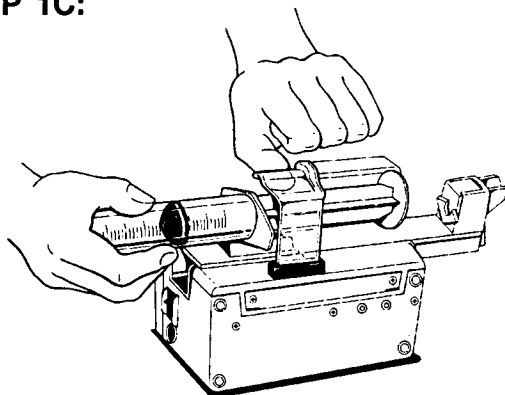

Insert the syringe, plunger end first.

STEP 1C continued: **NOTE:** To be certain that the syringe is properly placed in the pump, make sure the graduations/ numbers on the syringe face up.

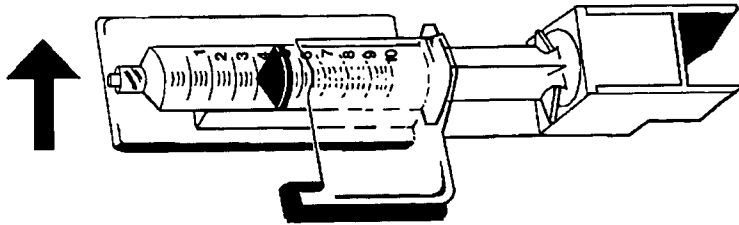

STEP 1D:

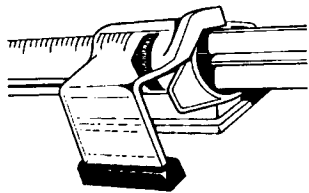

The clear syringe clamp must secure the syringe tabs within the syringe clamp groove. Syringe tabs can be rotated slightly.

Finger tabs should be parallel in relation to the clamp as shown:

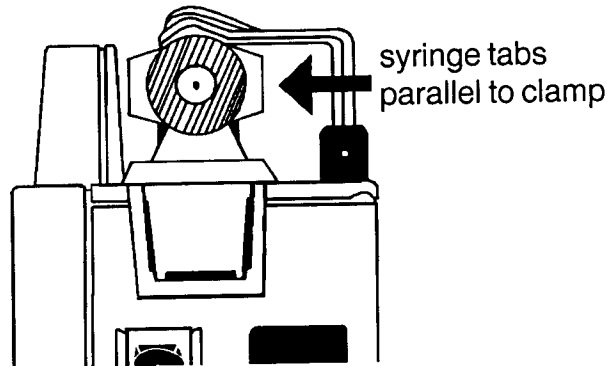

If not properly engaged, the pump may alarm after it has been in the deliver mode for a period of time.



CAUTION:

For all size syringes, be sure the finger tabs of the syringe engage the syringe clamp groove (retainer) and the syringe saddle.

STEP 1E:

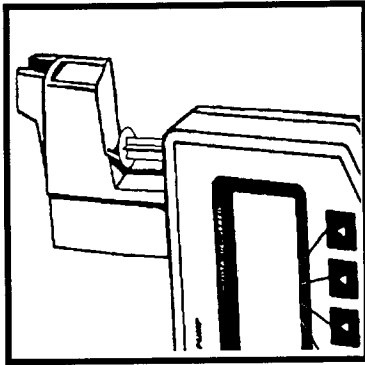

Pinch together the CLUTCH LEVER and move the SYRINGE DRIVER forward until the SYRINGE DRIVER contacts the plunger end of the DISPOSABLE SYRINGE.



IMPORTANT:

Make sure the CLUTCH LEVER snaps into its fully extended operating position.

STEP 1F:

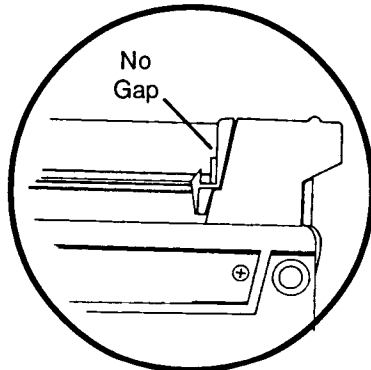

Insert the end of the SYRINGE PLUNGER into the SYRINGE PLUNGER RETAINER thus holding it in place. The SYRINGE PLUNGER may need to be lifted to load.



WARNING:

Failure to secure the syringe plunger to the plunger retainer may result in siphoning, causing overdelivery.

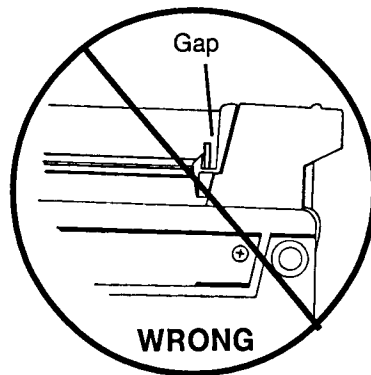

CAUTION:

The plunger must be in contact with the driver to begin immediate delivery. A gap could lead to a delay in delivery. Use the prime function to eliminate any gap.

STEP 1G: REMOVING THE SYRINGE:

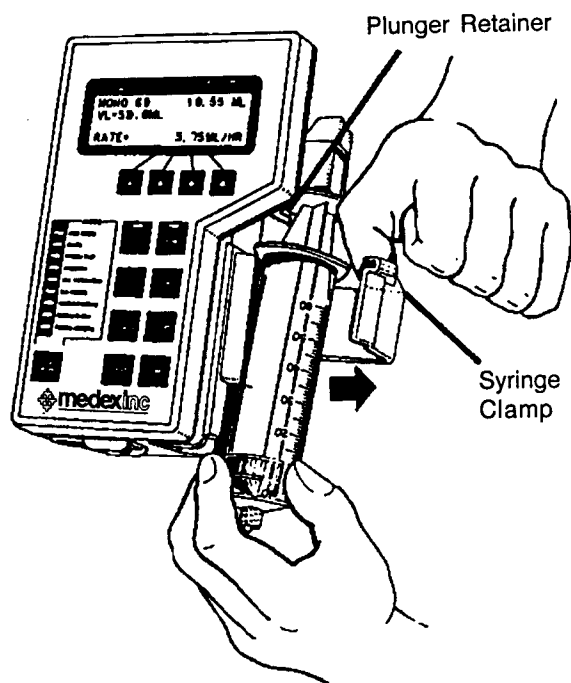

To remove syringe from pump: Lift up the clear syringe clamp and remove the empty syringe as shown.



IMPORTANT:

Be sure to lift the syringe plunger out of the plunger retainer (groove) before pulling the syringe out.

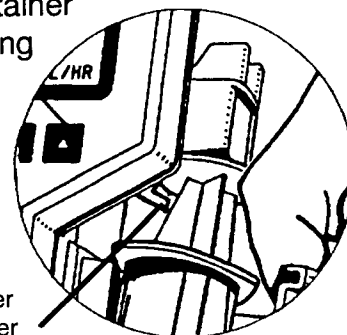

WARNING:

Failure to follow proper syringe removal procedures could cause damage to your pump, which may result in inaccurate drug delivery.

STEP 1H: OPTIONAL Loading Abbot Pre-Filled Syringe

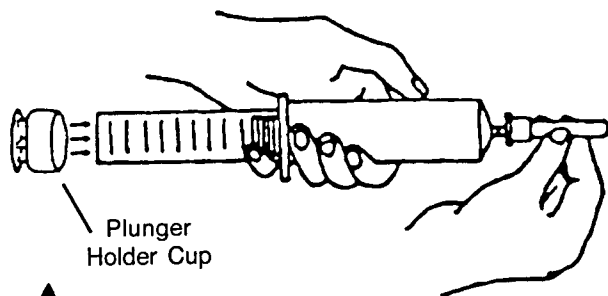

- Securely attach the plunger holder cup provided by Abbott to the end of the syringe plunger. (Glue or tape must be utilized to securely attach the plunger holder cup).
- Place the end of the cup into the plunger retainer as described in STEPS 1E and 1F.



WARNING:

Proper syringe loading and plunger holder cup placement is essential for proper delivery and actuation of the empty and near empty alarms. Improper use or the lack of use of the plunger holder cup may result in inaccuracy with ramifications that are drug dependent. Failure to secure the plunger holder cup to the syringe may result in siphoning, causing over-delivery.

SECTION 4: OPERATING INSTRUCTIONS CONTINUED...

STEP 2: TURNING THE PUMP "ON"; REVIEWING THE CUSTOM PROGRAMMED FEATURES AND PUMP SELF TEST

STEP 2A: The main power switch is located on the end of the pump. Switch it to its "on" position (i.e., 0 = Off, 1 = On).

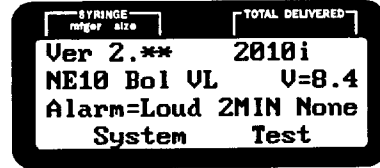

NOTE: Make sure the AC adaptor cord is plugged into an electrical outlet (unless battery power is required).

When "ON", the LCD displays the following information:

Line 1: Software Version, Pump ID

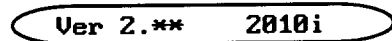

Line 2:

NE - Near Empty Alarm
(10 min. was programmed in Custom Programming)
Bol - Bolus feature was custom programmed.
VL - A Volume Limit was custom programmed.
V - Voltage of Battery at 8.4. (which indicates a full charge)

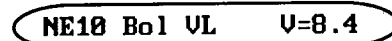

Line 3:

ALARM - (Soft or Loud can be chosen).
2 MIN - (Temporary alarm delay either 2 min. or 1 hour).
ALARM DELETED - Choice of none, #1 or #1 and #2 alarms.

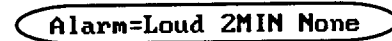

Line 4: System Test

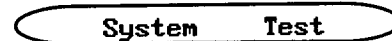

STEP 3: PROGRAMMING (INITIAL POWER-UP)

NOTE: The program key "LED" blinks and a slow intermittent beep (#1) sounds to indicate the Program Mode unless deactivated in Custom Programming. (The alarm temporarily silences by pressing the SILENCE ALARM key once). Program or function changes occur only in the STOP/PROGRAM Mode. A single audio peck indicates a valid key press (occurs even when the audio is silenced).

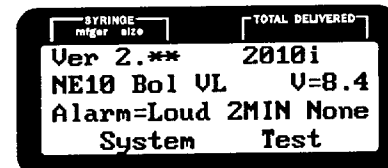

SECTION 4: OPERATING INSTRUCTIONS CONTINUED...

STEP 3A: If more than one syringe manufacturer is chosen in the custom program mode the bottom line displays: "Select Mfger:"

Use SELECT key to choose syringe manufacturer.

Use ENTER to confirm choice.

NOTE: *If only one syringe manufacturer is custom programmed, the pump automatically advances to STEP 3B.*

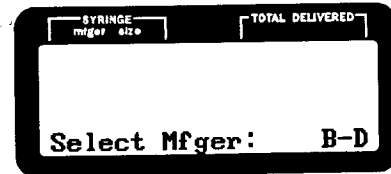

STEP 3B: The first line of the LCD displays the most recent mode programmed. Press ENTER to confirm this mode or press PROTOCOL to select from modes setup in custom programming. If more than 8 modes were setup, the PROTOCOL key toggles between the screens, beginning with any programmed user modes.

NOTE: *If the user modes have been previously custom programmed more screens will exist. (See Section 18: User Banks).*

Use SELECT key to choose desired mode.

Use ENTER key to confirm choice.

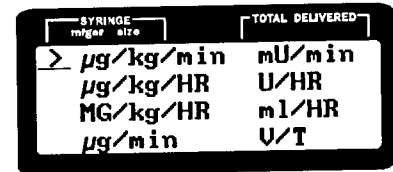
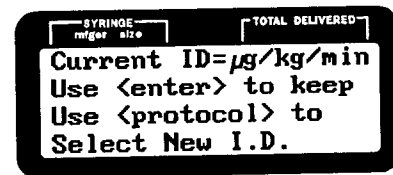

STEP 3C: The mode chosen appears in the right upper corner. If the syringe is not loaded, load it per instructions.



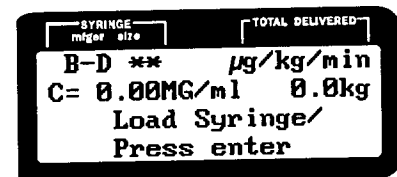

NOTE: *In this case µg/kg/min was chosen.*

The LCD displays "LOAD SYRINGE, PRESS ENTER".

Press ENTER key to confirm the syringe size.



STEP 3D: CONCENTRATION ENTRY

Use the RATE SELECTION KEY(s)
    to select the appropriate numerical value for concentration.



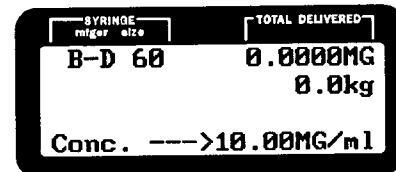
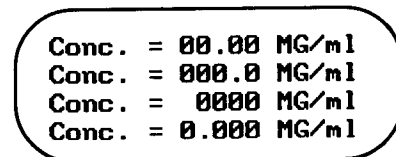
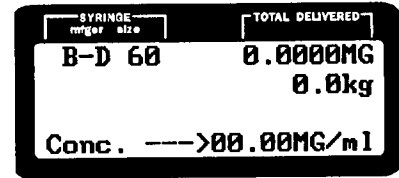

NOTE: *The decimal point may be moved by pressing the decimal shift key prior to numerical entry. However, it may not be moved if in User Bank "A" or "b".*

NOTE: *If decimal shift is pressed after numbers have been programmed the numbers will all change to zero.*

Press ENTER to confirm concentration.



STEP 3E: WEIGHT ENTRY

Use the RATE SELECTION KEY(s)
    to select the appropriate numerical value for weight.



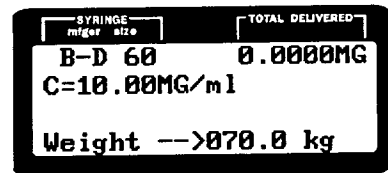

NOTE: *The decimal point cannot be shifted for weight and the minimum allowable entry is 000.1 and the maximum is 250.0 kg.*

Use ENTER key to confirm weight.



SECTION 4: OPERATING INSTRUCTIONS CONTINUED...

STEP 3F: BOLUS ENTRY

Use the RATE SELECTION KEY(S)
    to select the appropriate numerical value for the bolus amount.

NOTE: *The Decimal point may be moved by pressing decimal shift key prior to numerical entry. If it is moved after the numerical entry, the entry will be automatically reset to zero. However, the decimal point may not be moved if in User Bank "A" or "b".*



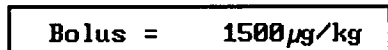
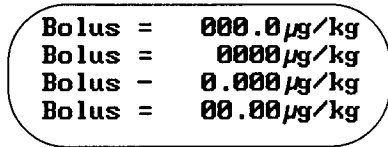
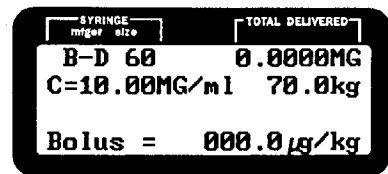

Press ENTER to confirm the bolus amount.

NOTE: *If no bolus is desired, enter value as zero.*

NOTE: *If bolus was not selected in the Custom Program Mode it will not be offered here.*



STEP 3G: RATE

Use the RATE SELECTION KEY(S)
    to select the appropriate numerical value for rate. Press ENTER key to confirm rate.

NOTE: *Decimal point may be moved by pressing decimal shift key prior to numerical entry. If it is moved after the numerical entry, the entry will be automatically reset to zero. However, the decimal point may not be moved in User Bank "A" or "b".*

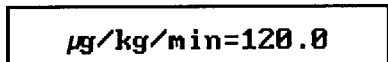
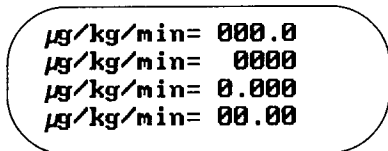
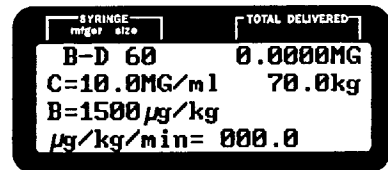

SECTION 5: INFUSION MODES (BODY-WEIGHT)

Body Weight Mode Introduction

The Body Weight Mode requires entries for concentration in mg/ml, weight in kg and dose. Additionally a bolus amount may be programmed.

Body Weight Mode includes:

- $\mu\text{g}/\text{kg}/\text{min}$
- $\mu\text{g}/\text{kg}/\text{HR}$
- $\text{mg}/\text{kg}/\text{min}$
- $\text{mg}/\text{kg}/\text{HR}$

Any or all of these will be available depending on which were chosen in Custom Programming.

STEP 1: PROGRAMMING SYRINGE MANUFACTURER

NOTE: *If a single syringe manufacturer is custom programmed, the pump automatically advances to the mode screen.*

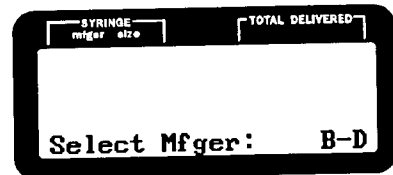

STEP 1A: Press SELECT key until the desired syringe manufacturer appears, then press ENTER to confirm.



The choices may be any combination of the following:

BD
MONO
TERU
BD-G
ABOT



WARNING:

Verify that the syringe manufacturer on the LCD is the same as the syringe in use. Failure to use the listed manufacturer could result in inaccurate delivery. The pump cannot automatically identify syringe manufacturer.

SECTION 5: INFUSION MODES (BODY-WEIGHT) CONTINUED...

STEP 2: SELECT MODE

STEP 2A: If the pump has been previously programmed the initial screen shows the last mode or the name programmed. If the current identification (*see Appendix 2: Definitions*) is satisfactory, press ENTER. If not press the PROTOCOL key to find the name or mode desired. Continued pressing of PROTOCOL reviews all ID's and modes available.

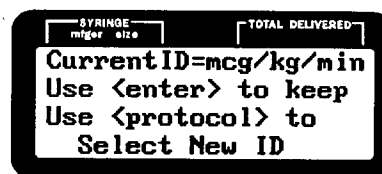

STEP 2B: The Body Weight Mode appears on the first *mode* screen. Select from up to four of the Body Weight Modes (depending how many were chosen in Custom Programming).

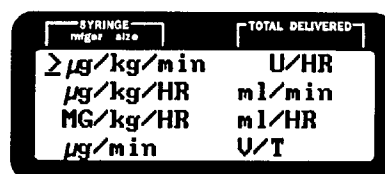

NOTE: *The mode screens appear in sequence after the customized user bank screens.*

Use the SELECT key to move the "flashing" cursor next to the mode chosen, then press ENTER to confirm.



STEP 3: PROGRAMMING SYRINGE SIZE

The fourth line of the LCD alternately flashes: "Load Syringe - Press enter". If the syringe is not already loaded onto the pump, load per instruction (*See Section 4: Operating Instructions*).

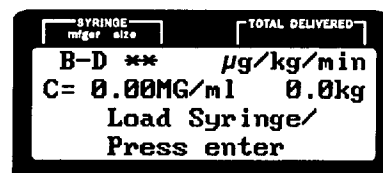

Once the syringe is properly loaded, press the ENTER key. The pump will automatically enter the syringe size and advance to the next programmable item, unless use of the B-D® luer lock syringe was selected in custom programming, in which case the operator must select syringe size (i.e., 1cc or 3cc). (*See Appendix 3*).



WARNING:

Always confirm that the syringe size stated on the LCD agrees with the size of the syringe loaded on the pump. Failure to select the correct syringe size will result in inaccurate delivery.



WARNING:

If the B-D® luer lock option was selected in custom programming, the operator must select the appropriate syringe size (i.e., 1cc or 3cc). The pump cannot distinguish between these syringe sizes.

STEP 4: PROGRAMMING THE CONCENTRATION

STEP 4A: DECIMAL SHIFT

If the decimal point is located appropriately, skip to STEP 4B. If the decimal needs to be moved, use the decimal shift key to move it to an appropriate location.

NOTE: Concentration is always programmed in MG/ml regardless of decimal location.

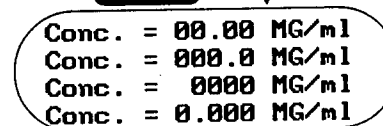
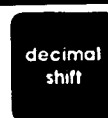
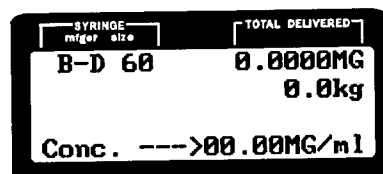

STEP 4B: To program a concentration, press the RATE SELECTION KEY(S) beneath the flashing numerals.

Press ENTER to confirm the desired concentration.

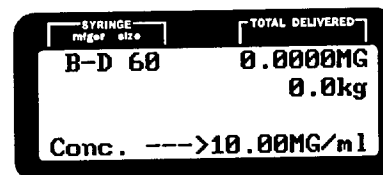

STEP 5: PROGRAMMING WEIGHT

To program a weight, press the RATE SELECTION KEY(S) beneath the flashing numerals.

Press ENTER key to confirm the desired weight.

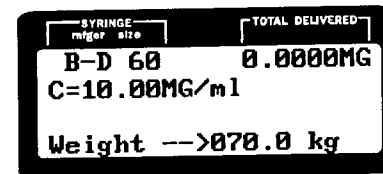

SECTION 5: INFUSION MODES (BODY-WEIGHT) CONTINUED...

STEP 6: PROGRAMMING A BOLUS

If BOLUS does not appear on the LCD, it was not custom programmed, skip to STEP 7.

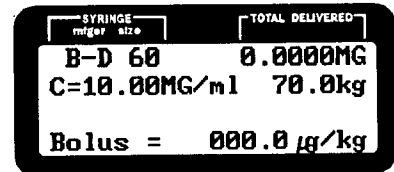

STEP 6A: DECIMAL SHIFT

If the decimal point is located appropriately, skip to Step 6B. If the decimal needs to be moved, use the decimal shift key to move it to an appropriate location.

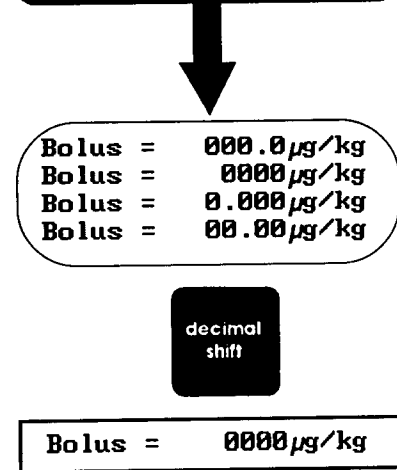

See tabbed section "BOLUS" for detailed information on programming, delivering and reprogramming bolus doses.

STEP 6B: To program a bolus, press the RATE SELECTION KEY(S) beneath the flashing numbers. The LCD automatically advances.

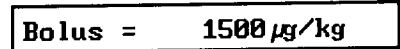

Press ENTER to confirm.



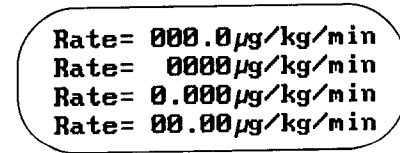
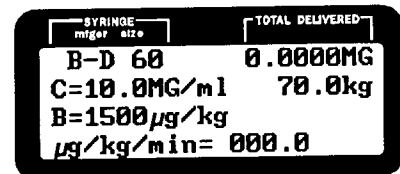

STEP 7: PROGRAMMING RATE

STEP 7A: DECIMAL SHIFT





If the decimal point is located appropriately, skip to STEP 7B. If the decimal needs to be moved, press the DECIMAL SHIFT key to move it to an appropriate location.

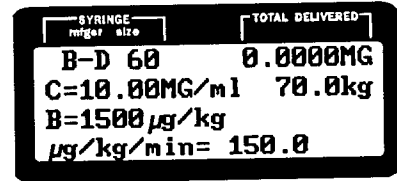

STEP 7B: PROGRAMMING RATE

To program a RATE, press the RATE SELECTION KEY(S)     located beneath the flashing numerals.



NOTE: Continuously pressing the RATE SELECTION KEY(S)     automatically advances the number.



Press ENTER to confirm the desired rate.

NOTE: Programming is complete when the display is solid (not flashing). The operator should PRIME to remove any mechanical slack before commencing delivery.

NOTE: INVALID NUMBER displays on the LCD when an invalid rate entry occurs followed by an appropriate rate programmable for the syringe selected.

STEP 8: PRIMING

For important detailed information on priming please see tabbed section "PRIME".

STEP 9: DELIVERY

STEP 9A: INITIATING DELIVERY

Press the DELIVER key to begin the infusion. The LCD will not flash and the green LED DELIVER light begins to blink.

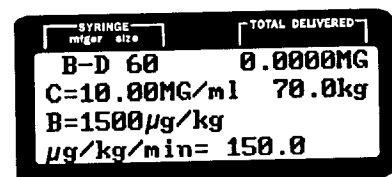

In the DELIVERY MODE all keys are inactive for programming except the ALARM ON/OFF key, the BOLUS and the RATE SELECTION key(s).

STEP 9B: DELIVERY-VIEW ML/HR AND SIMPLIFY SCREEN

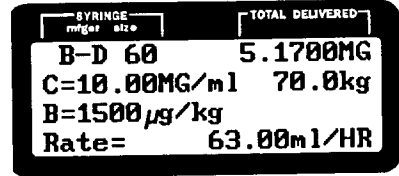

VIEW:

While delivering the operator can temporarily display the TOTAL DELIVERED in ml and the RATE in ml per hour by pressing and releasing the ENTER key.

NOTE: *The ml conversion can also be viewed in STOP/PROGRAM by pressing the ENTER key.*



SIMPLIFY:

Press the SELECT key while delivering to simplify the screen. Another press of SELECT will make the full screen reappear (*not shown*).



STEP 9C: CHANGING THE RATE

*The operator may change the infusion RATE by two methods: See tabbed section "**CHANGE RATE**" for detailed information on same.*

STEP 10: BOLUS PROGRAMMING

*See tabbed section "**BOLUS**" for detailed information on programming, delivering and reprogramming bolus doses.*

STEP 11: STOP DELIVERY

Press the STOP/PROGRAM key to stop the infusion. The STOP/PROGRAM LED blinks and a slow intermittent #1 audio alarm sounds, unless it has been deleted in Custom Programming (*See Section 10: Alarms/Alerts*).



SECTION 5: INFUSION MODES (BODY-WEIGHT) CONTINUED...

NOTE: Alarms (e.g.: occlusion, depleted battery, load syringe plunger, syringe pops out, etc.) interrupt delivery. Correct the alarm and press the DELIVER key to resume.

STEP 12: END OF DELIVERY

When the syringe empties, an EMPTY ALARM occurs (Type 2 Alarm unless deleted in Custom Programming). (See Section 10: Alarms/Alerts).

STEP 13: PROGRAMMING STANDBY TIME

The Standby Mode allows temporary suspension of an infusion while retaining all pertinent data (e.g.: rate, total delivered, syringe size, syringe manufacturer, etc.)

*See tabbed section "**STANDBY MODE**" for detailed information on programming and cancelling standby time.*

**Mass Mode
Introduction**

The Mass Modes allow for programming a concentration value, weight and a dose. The pump then calculates the volume (i.e., rate). Additionally a bolus amount may be programmed.

Mass Modes include:

$\mu\text{g}/\text{min}$	$\mu\text{g}/\text{HR}$
mg/min	mg/HR
Units/min	Units/HR
Milliunits/min	Milliunits/HR

Any or all of these modes will be available depending on which were chosen in custom programming.

**STEP 1: PROGRAMMING SYRINGE
MANUFACTURER**

NOTE: *If a single syringe manufacturer is custom programmed, the pump automatically advances to mode screen.*

STEP 1A: Press SELECT key until the desired syringe manufacturer appears, then press ENTER to confirm. Choices may be any combination of the following:

- B-D®
- MONO
- TERU
- BD-G
- ABOT

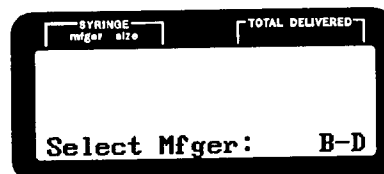

WARNING

Verify that the syringe manufacturer on the LCD is the same as the syringe in use. Failure to use the listed manufacturer could result in inaccurate delivery. The pump cannot automatically identify syringe manufacturer.

STEP 2: SELECT MODE

STEP 2A: If the pump has been previously programmed the initial screen shows the last mode programmed or the name.

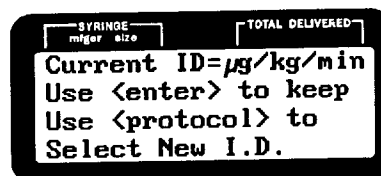

SECTION 5: INFUSION MODES (MASS MODE) CONTINUED...

If the current ID is satisfactory, press ENTER. If not, press the PROTOCOL key to find the name or mode desired. Continued pressing of the PROTOCOL key reviews all ID's and modes available.

STEP 2B: The Mass Mode appears on either the first or second *mode* screen (depending on how many modes were chosen in Custom Programming). Up to 8 Mass Modes may be selected.

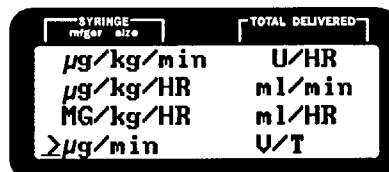

NOTE: The mode screens appear in sequence after the *customized User Bank* screens.

Use the SELECT key to move the flashing cursor next to the mode chosen then press ENTER to confirm.



STEP 3: PROGRAMMING SYRINGE SIZE

The fourth line of the LCD alternately flashes: "Load Syringe - Press enter". If the syringe is not already loaded onto the pump, load per instructions (See Section 4: Operating Instructions).

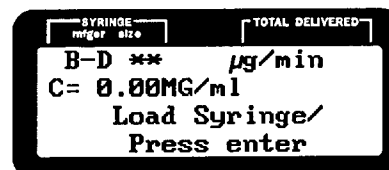

Once the syringe is properly loaded, press the ENTER key. The pump will automatically enter the syringe size and advance to the next programmable item, unless use of the B-D® luer lock syringe was selected in custom programming, in which case the operator must select syringe size (i.e., 1cc or 3cc). (See Appendix 3)



 **WARNING**

Always confirm that the syringe size stated on the LCD agrees with the size of the syringe loaded on the pump. Failure to select the correct syringe size will result in inaccurate delivery.



WARNING

If the B-D® luer lock option was selected in custom programming, the operator must select the appropriate syringe size (i.e., 1cc or 3cc). The pump cannot distinguish between these syringe sizes.

STEP 4: PROGRAMMING THE CONCENTRATION

STEP 4A: DECIMAL SHIFT

If the decimal point is located appropriately, skip to 4B. If the decimal needs to be moved, press the DECIMAL SHIFT key to move it to an appropriate location.

NOTE: Concentration is always programmed as MG/ml regardless of decimal location.

STEP 4B: To program a CONCENTRATION, press the RATE SELECTION KEY(S)  beneath the flashing numerals.

Press ENTER to confirm desired concentration.

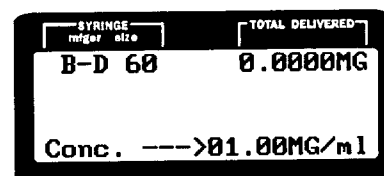
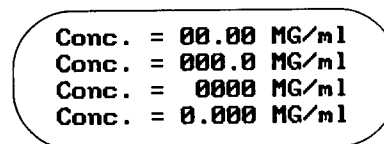
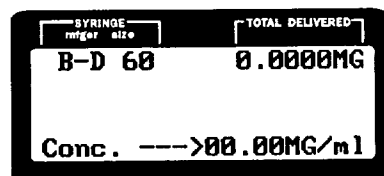

STEP 5: PROGRAMMING A BOLUS



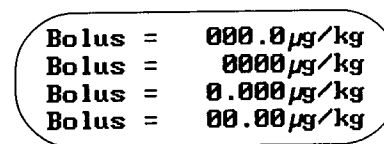
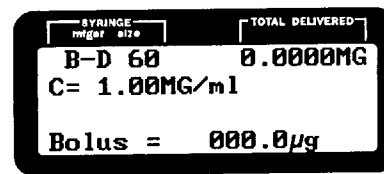

If Bolus does not appear on the LCD it was not custom programmed, the pump automatically skips to STEP 6.

STEP 5A: DECIMAL SHIFT

If the decimal point is located appropriately program bolus amount. If the decimal needs to be moved, use the DECIMAL SHIFT key to move it to an appropriate location.



SECTION 5: INFUSION MODES (MASS MODE) CONTINUED...

STEP 5B: To program a bolus, press the RATE SELECTION KEY(S)     beneath the flashing numerals. Press ENTER to confirm the desired bolus. The LCD automatically advances.

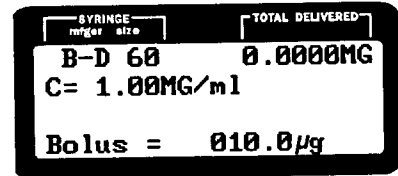

See the tabbed section "BOLUS" for detailed information on programming, delivering and reprogramming bolus doses.



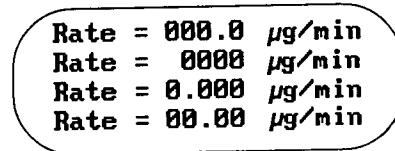
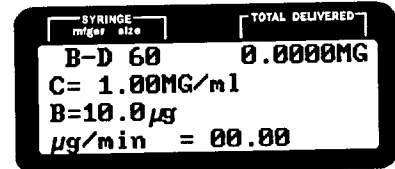

STEP 6: PROGRAMMING A RATE

STEP 6A: DECIMAL SHIFT

If the decimal point is located appropriately, skip to STEP 6B. If the decimal needs to be moved, use the decimal shift key to move it to an appropriate location.



STEP 6B: PROGRAMMING THE RATE

To program a RATE, press the RATE SELECTION KEY(S)     located beneath the flashing numerals.

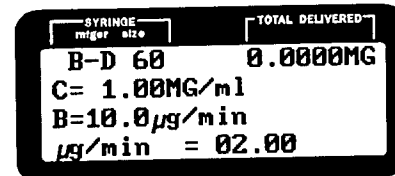

NOTE: *Continuously pressing the RATE SELECTION KEY(S) automatically advances the number.*

Press ENTER to confirm the desired rate.

NOTE: *Programming is complete when the display is solid (not flashing). The operator should PRIME to remove any mechanical slack before commencing DELIVERY.*

NOTE: *INVALID NUMBER displays on the LCD when an invalid rate entry occurs followed by an appropriate rate programmable for the syringe selected.*

STEP 7: PRIMING

For important detailed information on priming, please see tabbed section "PRIME".

STEP 8: DELIVERY

STEP 8A: INITIATING DELIVERY

Press the DELIVER key to begin the infusion. The LCD will not flash and the green LED DELIVER light begins to blink.

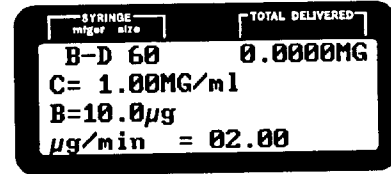

In the DELIVERY MODE, all keys are inactive except the SILENCE ALARM key, the STOP/PROGRAM key, the BOLUS and the SELECT, ENTER and the RATE SELECTION KEY(S).



STEP 8B: DELIVERY-VIEW ML/HR AND SIMPLIFY SCREEN

VIEW

While delivering the operator can temporarily display the TOTAL DELIVERED in ml and the RATE in ml per hour by pressing and releasing the ENTER key.

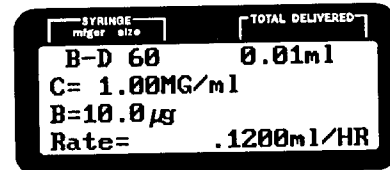

NOTE: *The ml conversion can also be viewed in STOP/PROGRAM by pressing the ENTER key.*



SIMPLIFY

Press the SELECT key while delivering to simplify the screen. Another press of SELECT will make the full screen reappear (not shown).



STEP 8C: CHANGING THE RATE

*The operator can change the infusion RATE by two methods. See tabbed section "**CHANGE RATE**" for detailed information on same.*

STEP 9: BOLUS PROGRAMMING

*See tabbed section "**BOLUS**" for detailed information on programming, delivering and reprogramming bolus doses.*

STEP 10: STOP DELIVERY

Press the STOP/PROGRAM key to stop the infusion. The STOP/PROGRAM LED blinks and a slow intermittent #1 audio alarm sounds, unless it was deleted in Custom Programming (*See Section 10: Alarms/ Alerts*).



NOTE: *Alarms (e.g.: occlusion, depleted battery, load syringe plunger, syringe pops out, etc.) interrupt delivery. Correct the alarm and press the DELIVER key to resume.*

STEP 11: END OF DELIVERY

When the syringe empties, an EMPTY ALARM occurs (Type 2 Alarm unless deleted in Custom Programming).

STEP 12: PROGRAMMING STANDBY TIME

The Standby mode allows temporary suspension of an infusion while retaining all pertinent data (e.g.: rate, total delivered, syringe size, syringe manufacturer, etc.).

*See tabbed section "**STANDBY MODE**" for detailed information on programming and cancelling standby time.*

SECTION 5: INFUSION MODES (CONTINUOUS MODE) CONTINUED...

the initial screen shows the last mode programmed or the name:

If the current ID is satisfactory, press ENTER. If not, press the PROTOCOL key to find name or mode desired. Continued pressing of the PROTOCOL key reviews all ID's and modes available.

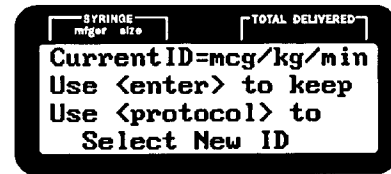

STEP 2B: The Continuous modes appear either on the first or second *mode* screen depending on how many modes were chosen in custom programming. You may select from 2 Continuous Modes.

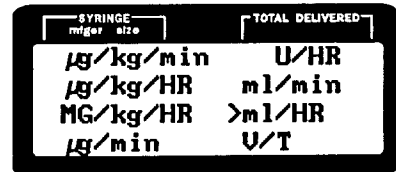

NOTE: *The mode screen appears in sequence after the customized User Bank Screens.*

Use the SELECT key to move the flashing cursor next to the mode chosen, then press ENTER to confirm.



STEP 3: PROGRAMMING SYRINGE SIZE

The fourth line of the LCD alternately flashes: "Load Syringe - Press enter".

If the syringe is not already loaded onto the pump, load per instructions (*See Section 4: Operating Instructions*).

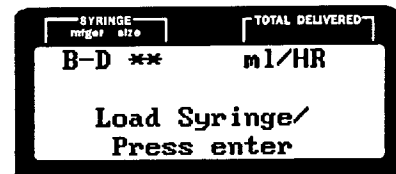

Once the syringe is properly loaded, press the ENTER key. The pump will automatically enter the syringe size and advance to the next programmable item, unless use of the B-D® luer lock syringe was selected in custom programming in which case the operator must select syringe size (i.e., 1cc or 3cc). (*See Appendix 3*).





WARNING:

Always confirm that the syringe size stated on the LCD agrees with the size of the syringe loaded on the pump. Failure to select the correct syringe size will result in inaccurate delivery.



WARNING:

If the B-D® luer lock option was selected in custom programming the operator must select the appropriate syringe size (i.e., 1cc or 3cc). The pump cannot distinguish between these syringe sizes.

STEP 4: VOLUME LIMIT

If volume limit does not appear on the LCD, it was not custom programmed, the pump automatically skips to STEP 5.

The volume limit (VL) allows delivery of a preprogrammed fluid volume from any size syringe. The pump stops automatically when the VL is reached.

Program the VL with the RATE SELECTION KEY(S) . Continuously pressing the RATE SELECTION KEY(S) automatically advances the number.

Press ENTER to confirm the desired VL. The LCD automatically advances.

NOTE: *If the VL is inappropriate for the syringe capacity, the LCD will display INVALID NUMBER and show an appropriate VL programmable for the syringe selected.*

STEP 5: PROGRAMMING A BOLUS

If a bolus does not appear on the LCD it was not custom programmed, the pump automatically skips to STEP 6.

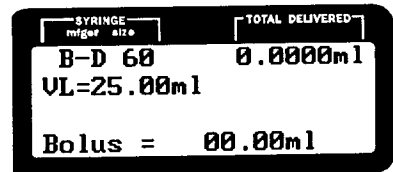
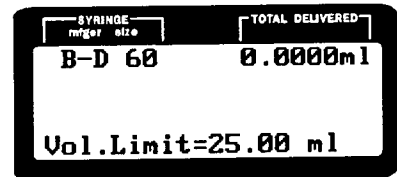
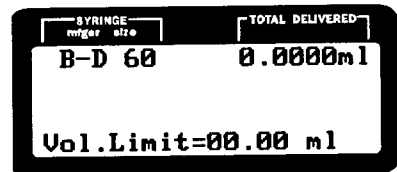

SECTION 5: INFUSION MODES (CONTINUOUS MODE) CONTINUED...

STEP 5A: DECIMAL SHIFT

If the decimal point is located appropriately, program the bolus amount. If the decimal needs to be moved, press the DECIMAL SHIFT key to move it to an appropriate location.

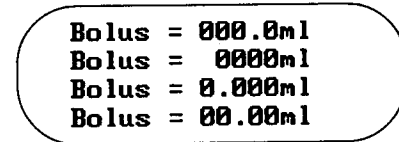
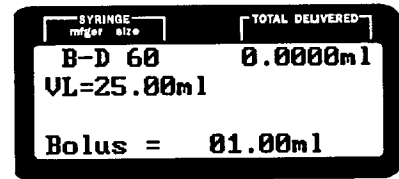

STEP 5B: PROGRAMMING A BOLUS

To program the BOLUS AMOUNT press the RATE SELECTION KEY(S) beneath the flashing numerals.

Press ENTER to confirm the desired BOLUS. The LCD automatically advances.



STEP 6: PROGRAMMING A RATE

STEP 6A: DECIMAL SHIFT

If the decimal point is located appropriately skip to 6B. If the decimal needs to be moved press the DECIMAL SHIFT key to move it to an appropriate location.

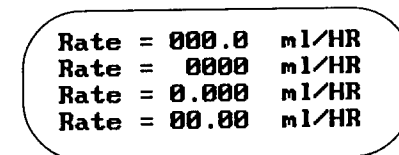
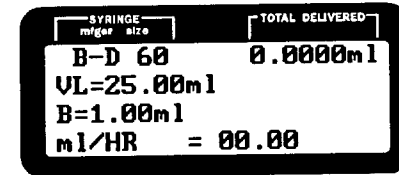

STEP 6B: PROGRAMMING THE RATE

To program a RATE, press the RATE SELECTION KEY(S) located beneath the flashing numerals.

NOTE: *Continuously pressing the RATE selection key automatically advances the number.*

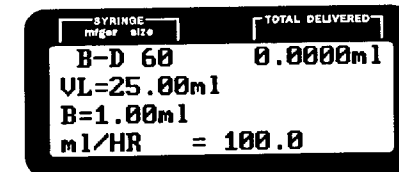

Press ENTER to confirm the desired rate.



NOTE: *Programming is complete when the display is solid (not flashing). The operator should PRIME to remove any mechanical slack before commencing delivery.*

SECTION 5: INFUSION MODES (CONTINUOUS MODE) CONTINUED...

NOTE: *INVALID NUMBER displays on the LCD when an invalid rate entry occurs followed by an appropriate rate programmable for the syringe selected.*



CAUTION:

The rate does not reset to 0 when the syringe size is changed.

STEP 7: PRIMING

For important detailed information on priming, please see tabbed section "PRIME".

STEP 8: DELIVERY

STEP 8A: INITIATING DELIVERY

Press the DELIVER key to begin the infusion. The LCD will not flash and the green LED DELIVER light begins to blink.

In the DELIVERY MODE, all keys are inactive except the SILENCE ALARM key, the STOP/PROGRAM key, the SELECT key, the BOLUS key and the RATE SELECTION KEY(S).

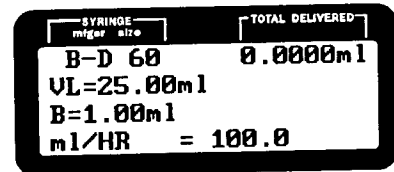

STEP 8B: RUNNING VOLUME (ONLY IF VL IS PROGRAMMED)

The running volume (RV) in hundredths of a ml is displayed on the LCD.

SECTION 5: INFUSION MODES (CONTINUOUS MODE) CONTINUED...

NOTE: *The RV records volume delivered since the last VL reset. By comparing the RV to the VL, one can determine how much more fluid must be delivered before reaching the VL. The RV is reset to zero when any of the following occur: change in syringe size, empty alarm, reprogramming the VL, when the VL is reached and when prime is used.*

NOTE: *The RV is not reset to 0 when the total volume delivered is reset, however.*

STEP 8B: CHANGING THE RATE

*The operator can change the infusion rate by two methods. See tabbed section "**CHANGE RATE**" for detailed information on same.*

STEP 9: BOLUS PROGRAMMING

*See tabbed section "**BOLUS**" for detailed information on programming, delivering and reprogramming bolus doses.*

STEP 10: STOP DELIVERY

Press the STOP/PROGRAM key to stop the infusion. The STOP/PROGRAM LED blinks and a slow intermittent #1 audio alarm sounds, unless deleted in Custom Programming (See Section 10: Alarms/ Alerts).



NOTE: *Alarms (e.g.: occlusion, depleted battery, load syringe plunger, syringe pops out, etc.) interrupt delivery. Correct the alarm and press the DELIVER key to resume.*

STEP 11: END OF DELIVERY

When the syringe empties, an EMPTY ALARM occurs (Type 2 Alarm unless deleted in Custom Programming). (See Section 10: Alarms/Alerts)

STEP 12: PROGRAMMING STANDBY TIME

The STANDBY MODE allows temporary suspension of an infusion while retaining all pertinent data (e.g.: rate, total delivered, syringe size, syringe manufacturer, etc.).

*See tabbed section, "**STANDBY MODE**" for detailed information on programming and cancelling standby time.*

SECTION 5: INFUSION MODES (VOLUME/TIME MODE)

Volume/Time Mode Introduction

The VOLUME/TIME mode requires entry of two infusion parameters -- the desired DOSE VOLUME (DV) and the desired DELIVERY TIME (DT). This mode is most useful in delivery of a single dose. The rate in ml per hour calculates automatically. The DOSE VOLUME becomes the VOLUME LIMIT (VL).

STEP 1: PROGRAMMING SYRINGE MANUFACTURER

NOTE: *If a single syringe manufacturer is custom programmed, the pump automatically advances to the mode screen.*

STEP 1A: Press the SELECT key until the desired syringe manufacturer appears, then press ENTER to confirm.

Choices may be any combination of the following:

BD
MONO
TERU
BD-G
ABOT



WARNING:

Verify that the syringe manufacturer on the LCD is the same as the syringe in use. Failure to use the listed manufacturer could result in inaccurate delivery. The pump cannot automatically identify syringe manufacturer.

STEP 2: SELECT MODE

STEP 2A: If the pump has been previously programmed the initial screen shows the last mode programmed or the name:
If the current ID is satisfactory, press ENTER.
If not, press PROTOCOL to find name or mode desired. Continued pressing of the PROTOCOL key reviews all ID's and modes available.

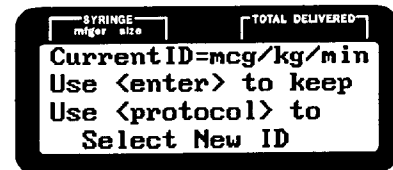
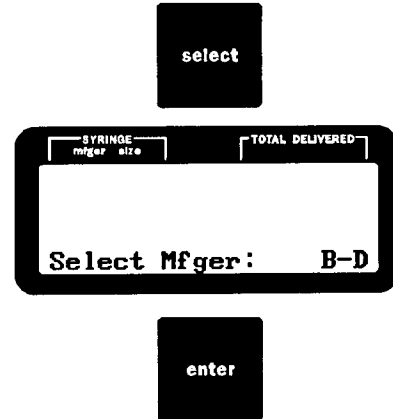

STEP 2B: The Volume Over Time (V/T) appears on the first or second *mode* screen depending on how many modes were chosen in Custom Programming. Use the SELECT key to move the flashing cursor next to V/T, then press ENTER to confirm.

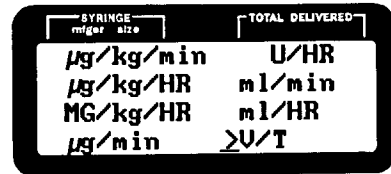

STEP 3: PROGRAMMING SYRINGE SIZE

The fourth line of the LCD alternately flashes "Load Syringe - Press enter".

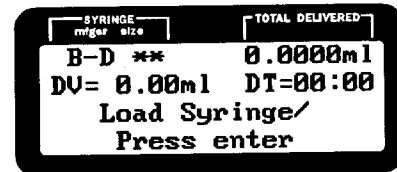

If the syringe is not already loaded onto the pump, load per instructions (See Section 4: Operating Instructions).

Once the syringe is properly loaded, press the ENTER key. The pump will automatically enter the syringe size and advance to the next programmable item unless use of the B-D® luer lock syringe was selected in Custom Programming in which case, the operator must select syringe size (i.e., 1cc or 3cc). (See Appendix 3).



WARNING:





Always confirm that the syringe size stated on the LCD agrees with the size of the syringe loaded on the pump. Failure to select the correct syringe size will result in inaccurate delivery.







WARNING:

If the B-D® luer lock option was selected in Custom Programming, the operator must select the appropriate syringe size (i.e. 1cc or 3cc). The pump cannot distinguish between these two syringe sizes.

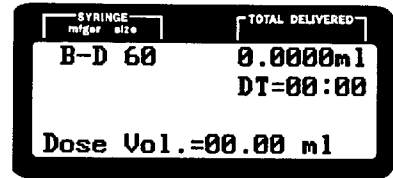
SECTION 5: INFUSION MODES (VOLUME/TIME MODE) CONTINUED...

STEP 4: PROGRAMMING DOSE VOLUME (DV)
 Press the appropriate RATE SELECTION KEY(S)     to program a DOSE VOLUME (DV).



NOTE: Continuously pressing the RATE SELECTION KEY(S)     automatically advances the number.

NOTE: The pump may be programmed to deliver a volume of 0.05 ml with the stipulation that the calculated rate must be equal to or greater than the minimum allowable rate for the chosen syringe size.

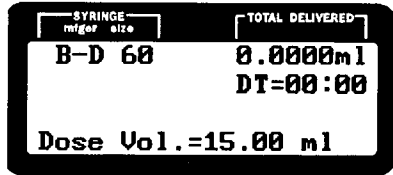

Press ENTER to confirm the desired DV. The LCD automatically advances.





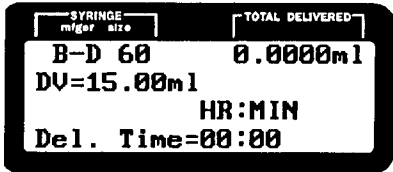

STEP 5: PROGRAMMING DELIVERY TIME (DT)

Press the appropriate RATE SELECTION KEY(S)     to program a delivery time (DT) in Hours:Minutes.



NOTE: Continuously pressing the RATE selection key automatically advances the number.

NOTE: Entries done with the  or  will

move in 1 hour increments.  or  will move in single minutes and roll over to hours when they exceed 60 minutes.

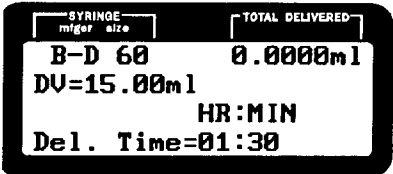

Press ENTER to confirm the desired DT. The LCD automatically advances.



NOTE: Invalid Number displays on the LCD when an invalid entry occurs. The maximum (or minimum) valid infusion time appears for the DV selected.

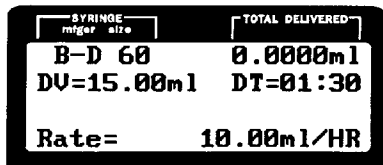

SECTION 5: INFUSION MODES (VOLUME/TIME MODE) CONTINUED...

The pump automatically calculates the rate and all information on the LCD is solid (not flashing). The operator should PRIME to remove any mechanical slack before commencing delivery.

STEP 6: PRIMING

For important detailed information on priming, please see tabbed section "PRIME".

STEP 7: DELIVERY

Press the DELIVER key to begin the infusion. The LCD will not flash and the green LED DELIVER light begins to blink.



The RUNNING VOLUME (RV) appears on the LCD when delivery begins.

In the DELIVERY MODE, all keys are inactive for programming except the ALARM ON/OFF key and the STOP/PROGRAM key.

STEP 8: RUNNING VOLUME

The RV in hundredths of a ml will be displayed on the LCD.

NOTE: *The RV records how much of the DOSE VOLUME (e.g.: VOLUME LIMIT) has been delivered. The RV is reset to zero when any of the following events occur: change in syringe size, empty alarm, reprogram the DV, the DV is reached and when PRIME is used.*

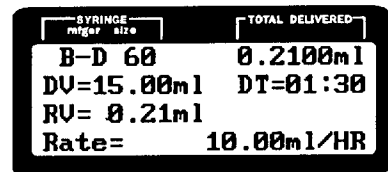

STEP 9: STOP/END DELIVERY

SECTION 5: INFUSION MODES (VOLUME/TIME MODE) CONTINUED...

STEP 9A: STOP DELIVERY

Press the STOP/PROGRAM key to stop the infusion. The STOP/PROGRAM LED blinks and a slow intermittent #1 audio alarm sounds unless deleted in Custom Programming (See Section 10: Alarms/Alerts).



NOTE: Alarms (e.g.: occlusion, depleted battery, load syringe plunger, syringe pops out, etc.) interrupt delivery. Correct the alarm and press the DELIVER key to resume. The remaining DV is given at the proper rate.

STEP 9B: END OF DELIVERY

When the DV is reached, the Type 2 alarm sounds unless disabled in Custom Programming. The LCD says "DOSE VOL. DELIVERED" "PRESS ENTER" and the STOP/PROGRAM LED blinks indicating delivery cessation. To silence the audio alarm, press the SILENCE ALARM key (See Section 10: Alarms/Alerts).

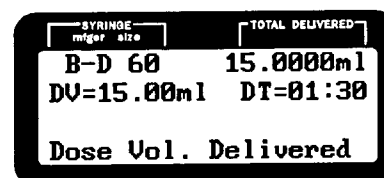

NOTE: The DV only equals the TOTAL DELIVERED readout during the administration of the first infusion. To continue the infusion, press DELIVER. The RUNNING VOLUME resets to zero (RV=0.00 ml) and another dose can be given. For example, if two DV amounts are delivered, the TOTAL DELIVERED amount will equal twice the DV amount.

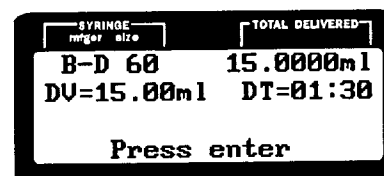

STEP 10: PROGRAMMING STANDBY TIME

The STANDBY MODE allows temporary suspension of an infusion while retaining all pertinent data (e.g.: rate, total delivered, syringe size, syringe manufacturer, etc.)

See tabbed section "**STANDBY MODE**" for detailed information on programming and cancelling STANDBY TIME.

SECTION 6: Bolus

Bolus Delivery

To administer a bolus, the pump may be delivering or paused.

- ▷ Press BOLUS, then DELIVER. The BOLUS delivered is continuously updated on the LCD and the bolus deliver LED is lit.
- ▷ At the end of bolus delivery there will be 2 short beeps.
- ▷ If bolus was given during non-delivery, the pump will return to non-delivery after the bolus is complete.
- ▷ If a bolus was given during delivery, the pump will resume delivery when the bolus is completed.

Reprogramming A Bolus:

During delivery or while paused, press the BOLUS key. Bolus amount will flash.

Bolus= 1500 mcg/kg

Change BOLUS to desired amount and

- (a) Press ENTER to store.
or
- (b) Press DELIVER to immediately deliver.

Interrupting A Bolus:

Bolus delivery may be interrupted at any time by one of two methods:

- (a) Press STOP. This will stop bolus as well as stopping previous rate.
- (b) Press DELIVER. This will stop bolus and resume or start programmed rate.

Temporarily Deprogramming A Bolus:





During delivery, press BOLUS then change amount to zero. Then press ENTER. During STOP or programming, press BOLUS button then press any two rate keys simultaneously to change to zero. Then press ENTER.

Note: *Bolus may be recalled at any time by pressing BOLUS as long as bolus delivery was chosen in Custom Program Mode.*

SECTION 7: Change Rate

The operator can change the infusion rate by two methods:





1. STOP THE PUMP

- ▷ Press STOP/PROGRAM.
- ▷ Press the RATE SELECTION KEY(S)     to start rate flashing: program a new rate.
- ▷ Press the ENTER key.
- ▷ Press the DELIVER key.



OR

2. DON'T STOP THE PUMP

- ▷ Press any RATE SELECTION KEY(S)     and when rate flashes, press RATE key to readjust existing rate to new rate.
- ▷ Press ENTER to change to the newly programmed rate.



SECTION 8: Prime

Press and hold the PRIME key to purge air from the administration set. The LCD states "PRIME VOL - 00.00ML" and the pump runs at its fastest rate. After approximately 16 seconds elapses, a continuous Type 3 Alarm sounds. However, the pump continues to prime when the key is held down (*See Section 10: Alarms/Alerts*).

Prime Vol= 00.00 ml

The amount delivered while priming is NOT counted by the TOTAL DELIVERED counter. However, the priming amount is shown on the prime volume counter.

prime

The PRIME function only activates when the pump is in the STOP/PROGRAM MODE and all other functions are entered (e.g.: Syringe Manufacturer, Syringe Size, Bolus Amount and Rate).

Prime Vol= 00.30ml



CAUTION: The prime function should be utilized when placing a newly filled syringe on the pump or when attaching an infusion set. Priming will displace the air in the set with the infusate and removes mechanical slack before starting delivery. This assures that the syringe driver and plunger are in contact.



WARNING: Do not operate the pump in the prime function while connected to the patient. This could cause over-delivery of infusate or an infusion of air purged from the set.

NOTE: When priming, the occlusion alarm may occur if a small bore Mini-vol™ extension set is used. Intermittently press and release the PRIME key (versus pressing and holding it continuously) to alleviate this problem.

SECTION 9: Standby Time

PROGRAMMING STANDBY TIME



WARNING:

If any alarms are deleted in the Custom Program Mode, the STOP/PROGRAM audio alarm may be disabled, therefore an audio alarm will not occur when the STANDBY TIME elapses in the STANDBY MODE.

The STANDBY MODE allows temporary suspension of an infusion while retaining all pertinent data (e.g. rate, total delivered, syringe size, syringe manufacturer, etc.). The STANDBY TIMER delays the occurrences of the STOP/PROGRAM audio alarm by the time programmed.

Press the STOP/PROGRAM key to stop the infusion. The pump must be in the STOP/PROGRAM mode. Press at the same time the STOP/PROGRAM and ENTER keys then release both.

The last line of the LCD will appear as shown.

Press the ENTER key. The LCD displays "STBY Time = 00:00".

Program the desired STANDBY TIME in hours and minutes (e.g. 03:30 for three hours and thirty minutes) with the RATE keys.

NOTE: *Time entries in minutes that equal or exceed 60 [i.e., 00:60 to 00:99] are converted to hours [i.e., 01:00 to 01:39]. The time entry then must be confirmed by pressing the ENTER key.*

Press ENTER to start the timer. The LCD states "STBY Time = 03:30". The time shown on the LCD will begin to count down.

NOTE: *When the STANDBY TIME elapses, "STBY TIME = 00:00" disappears from the screen, the STOP/PROGRAM audio alarm sounds and the previously programmed rate reappears.*

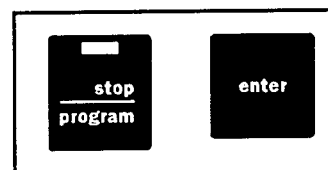

<sel>/<ent>:Stand-by

enter

STBY Time= 00:00

STBY Time= 03:30

enter

STBY Time= 03:30

STBY Time= 00:00

Press the DELIVER key to begin delivery.



CANCELLING THE STANDBY TIME

Press the STOP/PROGRAM key to return the pump to the previously programmed setting.



Press the DELIVER key to begin delivery.



SECTION 10: Alarms/Alerts

A. INTRODUCTION

The pump incorporates a series of ALARMS which are depicted in this section.

NOTE: Review Section 3 - General Description for specifics on how the SILENCE ALARM key functions.

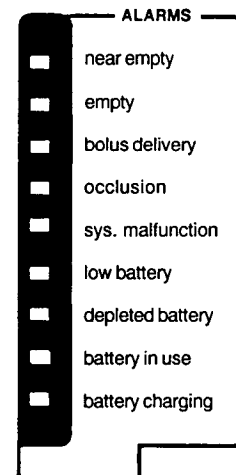

B. PROCEDURE FOR CORRECTING OCCLUSION ALARM

Troubleshoot by first checking for:

1. Kinks in tubing.
2. Stop cocks and clamps which are turned off thus prohibiting flow.
3. Clotted IV catheter or needle.
4. Something preventing movement of the Syringe Driver.
5. Make sure syringe is not empty.

Press the DELIVER key to restart the infusion once the occlusion is relieved/corrected.

NOTE: The pump STOPS INFUSING if an occlusion alarm occurs.



WARNING:

When an occlusion occurs and is corrected, there is a risk of infusing the pressurized build-up of infusate. To avoid inadvertent BOLUS, relieve the pressure before restarting the infusion.

C. PROCEDURE FOR SYSTEM MALFUNCTION

This alarm indicates that something has disrupted the operation of the microprocessor. Failures, which would activate this alarm, are some over and under deliveries and electrical component failures.



WARNING:

If this alarm occurs, record any operating data such as TOTAL VOLUME DELIVERED, RATE, SYRINGE MANUFACTURER, SYRINGE SIZE, etc. Once the pump is turned off, this information is not retained. Remove the pump from service and consult the manufacturer.

D. NEAR EMPTY ALARM

Under most conditions, the NEAR EMPTY ALARM automatically sounds 3 beeps 5 to 60 minutes (dependent upon Custom Programmed Option) before the syringe becomes physically empty unless Type 1 alarms are deleted in Custom Programming. The pump continues to deliver after the NEAR EMPTY ALARM sounds. However, be aware of the following: If a volume limit is programmed and is less than the fluid in the syringe, the volume limit alarm will sound at the appropriate point and the infusion will stop. If a volume limit is programmed to be larger than the fluid remaining, a NEAR EMPTY alarm and EMPTY ALARM will sound at the end of the syringe. No Volume Limit Alarm will sound. If a volume limit value just slightly less than the volume of fluid in the syringe is programmed as a volume limit, the near empty alarm will sound, then the volume limit alarm may sound.

E. EMPTY ALARM

The EMPTY ALARM's actuation point is determined by a mathematical formula based on the Syringe Manufacturer and Syringe Size.

Whenever an EMPTY ALARM sounds (Alarm #2), the operator should visually verify that the syringe in use is EMPTY.

The operator must decide to terminate the infusion or replace the syringe with a new supply of infusate.

NOTE: *The pump stops delivering when the EMPTY ALARM SOUNDS. The audio #2 alarm may be temporarily silenced by pressing the SILENCE ALARM key. The Type 2 alarms may be deleted in Custom Programming.*

If the syringe has any fluid remaining to deliver, restart the infusion by pressing the DELIVER key. The NEAR EMPTY ALARM will sound and when the syringe is empty you will receive a second EMPTY ALARM.

NOTE: *That the RV is reset but the total volume delivered is cumulative.*

F. SYRINGE POPS OUT

This alarm occurs if the syringe is disturbed during the infusion. A type 3 (i.e., continuous alarm) sounds and the fourth line of the LCD alternates between "PRESS ENTER" and "SYRINGE POPS OUT!".

To correct press the ENTER key. Confirm that the syringe is loaded properly. Then press ENTER again to verify syringe size. Press DELIVER to continue the infusion. The audio alarm is temporarily silenced by pressing the SILENCE ALARM key.

G. CHECK CLUTCH

If the clutch is manually disengaged for a period of time or the drive is manually moved during delivery a "CHECK CLUTCH" alarm results. A type 3 (i.e., continuous alarm) sounds and the fourth line of the LCD alternates between "PRESS ENTER" and "CHECK CLUTCH"!!

Make sure the clutch is fully engaged and that the syringe is properly loaded. Press ENTER to confirm clutch check and then press DELIVER to continue the infusion. The audio alarm is temporarily silenced by pressing the SILENCE ALARM key.

H. INVALID SIZE

This alarm occurs if the syringe loaded on the pump is not the size which is stored in the pump. In addition, please note that the pump cannot always distinguish between the same size syringe for different manufacturers.

To correct, confirm that the syringe manufacturer programmed is the same as the syringe being utilized. Also verify that the area between the syringe barrel and SYRINGE CLAMP is kept clear of labels, etc. and that the syringe finger tabs are oriented as described in this manual.

I. INVALID NUMBER

This LCD message occurs with entry of a parameter which cannot be accepted by the computer. Two beeps sound and the first valid number is displayed (for example, a rate too fast for the syringe selected, a volume limit greater than the volume of the syringe selected, the time between doses is less than or equal to the delivery time, in V/T where the desired delivery time is too fast for the volume chosen, etc.).

J. LOW BATTERY

The low battery alarm occurs approximately 30 minutes before battery depletion at rates under 5 ml/HR or less. The low battery LED lights and two beeps occur intermittently every 15 seconds. The audio alarm may be permanently silenced by pressing the SILENCE ALARM key once. The LED will remain on.

K. LOAD SYRINGE PLUNGER

1. Prior to infusion, if the syringe plunger is not in proper contact with the syringe plunger retainer, 2 short beeps will sound. An alternating LCD message "Load Syringe Plunger", "Press enter" displays.
2. During delivery if the syringe plunger and the syringe plunger retainer lose contact with the driver the infusion will stop. A continuous alarm will sound and an alternating LCD message "Load Syringe Plunger", "Press enter" appears.

L. END OF BOLUS

At the end of a programmed bolus delivery, 2 short beeps sound. If the bolus delivery is stopped prior to completion, the alert will not occur.

M. OCCLUSION SENSING

The Medfusion 2010i Syringe Pump can operate at variable sensitivities to occlusion. The occlusion sensitivity set at the manufacturer (unless otherwise specified) is normal. Three other options exist for the force setting including "LOW", "INT" and "HIGH". The best options may be selected for the specific clinical application.

To change the force setting on the Medfusion 2010i Syringe Pump consult the manufacturer, the service manual or the manufacturer's technical personnel.

If LOW, INT, or HIGH are selected the syringe size will be followed by an L, I, H respectively so the operator will be able to identify the proper force table.

The PSI setting is theoretically derived. Generally, the actual PSI will be lower than the theoretical value. The actual output pressure is affected by a multiplicity of factors including syringe size, friction between syringe barrel and plunger, catheter gauge, internal diameter of the tubing, durometer of the tubing, residual volume of tubing, rate of infusion, use of various in line devices including stopcocks/filters/valves, etc.

For example, making changes to the force setting with use of a Monoject 35cc syringe affects the following:

Monoject 35 cc syringe:

Normal	11.0 force (lbs)	16.40 maximum theoretical psi
Low	4.0 force (lbs)	5.96 maximum theoretical psi
Intermediate	6.88 force (lbs)	10.2 maximum theoretical psi
High	15.0 force (lbs)	22.30 maximum theoretical psi

For further information on theoretical values for other syringe sizes/settings, please contact **The Medex Technical Service Department** at **1-800-648-0840**.



IMPORTANT:

Any setting may produce false occlusion alarms, however, in general the lower occlusion pressure settings are more likely to create false occlusion alarms.

SECTION 10: ALARMS/ALERTS CONTINUED..

ALARM OR ALERT	AUDIO See "A"	TEMP. AUDIO OFF See "B"	VISUAL LED	AUTO. ADJUSTED	LCD MESSAGE	DEF. TO STOP/ PROG	INFUSION AUTO. STOPS	WHAT TO DO
STOP/ PROGRAM	#1	YES	YES-AT KEY(Red)	N/A	NONE	N/A	YES	PROGRAM OR TURN PUMP OFF
NEAR EMPTY	3 Beeps	N/A	YES (Yellow)	Custom Program for 5 TO 60 MIN.	NONE	NO	NO	PREPARE TO TERMINATE INFUSION OR LOAD A NEWLY FILLED SYRINGE.
EMPTY	#2	YES	YES (Red)	YES	NONE	YES	YES	TERMINATE INFUSION OR LOAD A NEWLY SYRINGE.
BOLUS DELIVERY	NONE	N/A	YES (Yellow)	N/A	Bolus Del=	NO	NO	N/A
OCCLUSION	#3	YES	YES (Red)	YES	NONE	YES	YES	CORRECT PROBLEM AND PRESS DELIVER TO RESTART INFUSION.
SYSTEM MALFUNCTION	#3	NO-MUST TURN OFF MAIN POWER	YES (Red)	NONE	SYSTEM ERROR	YES	YES	REMOVE UNIT FROM SERVICE AND CONSULT MANUFACTURER.
BATTERY CHARGING	NONE	N/A	YES (Green)	N/A	NONE	N/A	NO	INFORMATION ONLY.
BATTERY IN USE	NONE	N/A	YES (Yellow)	N/A	NONE	N/A	NO	INFORMATION ONLY.
LOW BATTERY	2 QUICK #1 W/15 SEC. DELAY	*PERMANENT	YES (Yellow)	YES-APPROX. 30 MIN. POWER REMAIN	NONE	NO	NO	PLUG INTO MAIN AC AS SOON AS POSSIBLE.
DEPLETED BATTERY	#3	YES	YES (Red)	N/A	Bat.Depl/ Plug in AC	YES	YES	PUMP CANNOT INFUSE UNLESS PLUGGED INTO AC. ALLOW TIME FOR BATTERY TO RECHARGE.
SYRINGE POPS OUT	#3	YES	NO	N/A	"Syringe Pops Out" "Press enter"	YES	YES	RELOAD SYRINGE, CONFIRM SYRINGE SIZE
PRIMING	#3 (16 SEC. DELAY)	NO	NO	N/A	Prime Vol=	N/A	N/A	N/A
DELIVER	NONE	N/A	YES-AT KEY(Green)	N/A	NONE	N/A	N/A	N/A

SECTION 10: ALARMS/ALERTS CONTINUED..

ALARM OR ALERT	AUDIO See "A"	TEMP. AUDIO OFF See "B"	VISUAL LED	AUTO. ADJUSTED	LCD MESSAGE	DEF. TO STOP/PROG	INFUSION AUTO. STOPS	WHAT TO DO
VALID KEY PRESS	ONE PECK	NO	N/A	N/A	N/A	N/A	N/A	N/A
CHECK CLUTCH	#3	YES	NO	N/A	"Check Clutch", "Press enter"	YES	YES	PRESS ENTER THEN DELIVER. IF ALARM RECURS CONSULT SERVICE MANUAL OR QUALIFIED BIOMEDICAL PERSONNEL (SEE "C" BELOW)
END OF BOLUS	2 short beeps	YES	NO	N/A	NO	YES/NO	YES/NO	RESUMPTION OF DELIVERY IS DEPENDENT UPON WHETHER BOLUS IS INITIATED IN DELIVER OR NON-DELIVER MODE.
LOAD SYRINGE PLUNGER	#3	YES	NO	N/A	"Load Syringe Plunger", "Press enter"	YES	YES	DURING INITIAL PROGRAMMING "LOAD SYRINGE PLUNGER" DISPLAYS ON THE LCD IF NOT LOADED PROPERLY ALONG WITH 2 BEEPS.
CHECK FORCE SENSOR	#2	NO	NO	N/A	"Check Force Sensor" "Press enter"	N/A	N/A	RELEASE CLUTCH LEVER. IF INEFFECTIVE CONSULT QUALIFIED BIOMEDICAL PERSONNEL.
CHECK PLUNGER SENSOR	#2	NO	NO	N/A	"Check Plunger Sensor" "Press enter"	N/A	N/A	SYRINGE PLUNGER IS NOT PRESENT WHILE PLUNGER DETECTOR IS ENGAGED.

- (A) Alarm audio Type #1 is short beeps with long intervals: Type #2 short fast beeps: Type #3 continuous tone.
 (B) Temporary audio off resets to audio on after 2 minutes or 60 minutes (off-line programmable) or the audio can be turned back on by pressing the SILENCE ALARM key for a second time.
 (C) A check clutch alarm occurs if the track does not move at the proper speed according to the rate set on the pump, or if the clutch is disengaged for a period of time during delivery. If the driver is moved manually during delivery a check clutch alarm occurs.

N/A = Not Applicable

*Alarm will not react once SILENCE ALARM pressed.

SECTION 11: Battery Power

- A. The pump batteries simultaneously recharge while operating and while the pump is turned OFF but plugged into AC. The batteries cannot be overcharged. The BATTERY CHARGING LED indicates that electricity is reaching the batteries.
- B. If the LOW BATTERY LED lights while the pump is running, the pump should be placed on AC as soon as possible. However, pump operation is not comprised in the low battery state.
- C. If the pump is allowed to reach DEPLETED BATTERY, the LED lights and the Type #3 audio alarm sounds. The pump is no longer able to continue operating on battery. To continue the infusion, the pump must be plugged into the wall. The LCD appears as described in D below.
- D. If a depleted battery condition exists upon turning the pump ON, the last line on the LCD will state:

Bat. Depl/Plug in AC

The pump must be plugged into AC, programmed and the DELIVER key pressed before commencing operation.

- E. The LCD backlight is normally off when the pump is operating on battery power. With activation of any key on battery power, the BACKLIGHT stays on for 15 seconds. The backlight is always lit when the pump is operating on AC power.
- F. To display the battery recharge time with the pump turned OFF, press and hold both the STOP/PROGRAM and DELIVER keys, then turn the pump on. The pump must be plugged into AC in order to accrue battery recharge time.

Both the recharge time and battery voltage continuously display. The battery voltage displays after a 60 second delay.

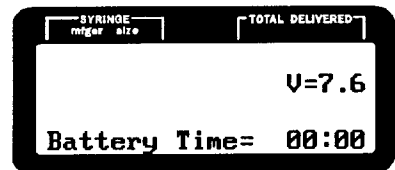

FOR EXAMPLE:

This display indicates the batteries have been recharging for ten hours seventeen minutes and the present battery voltage equals 8.0 volts.

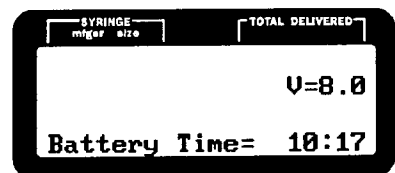

SECTION 12: Battery Voltage

To check the charge status of the batteries:

1. Unplug the AC adaptor.
2. Turn the pump ON.
3. Review the voltage stated on the second line of the LCD.

V=7.8

NOTE:

A voltage greater than 8.2 volts indicates a nearly FULL CHARGE; however, pump should be recharged for 16 hours to insure a FULL CHARGE. A voltage less than 7.3 volts indicates a LOW BATTERY condition.

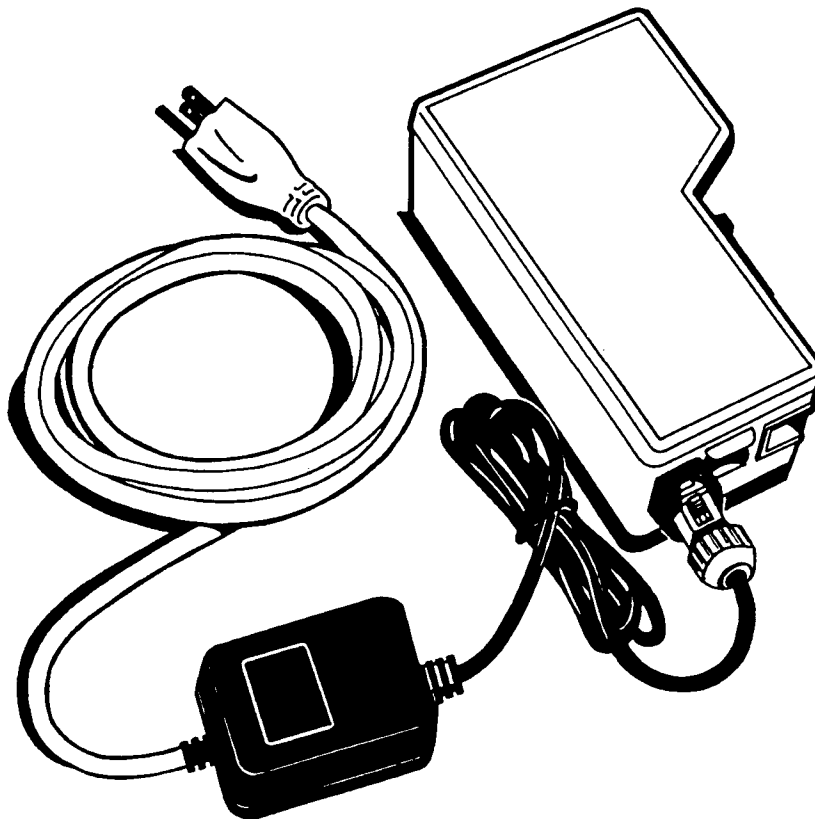
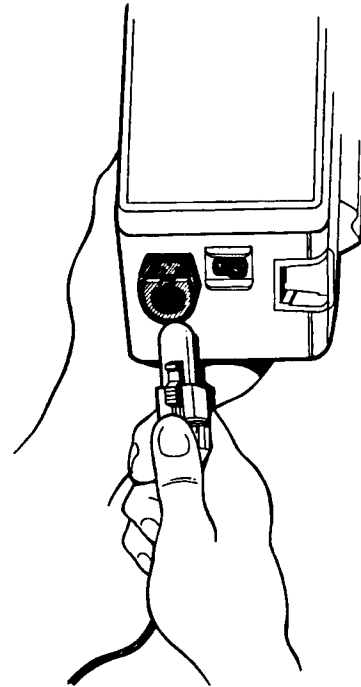

SECTION 13: IV Pole Clamp/Accessories

A. INTRODUCTION

The Rotating Pole Clamp is designed to provide maximum flexibility when mounting or transporting your syringe pump. Special features include a quick release lock and full pump rotation capabilities.

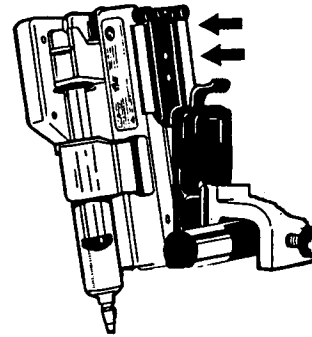

B. ATTACHING THE MOUNTING PLATE

The Pole Clamp Mounting Plate is secured to the pump with two flat head screws provided by manufacturer.

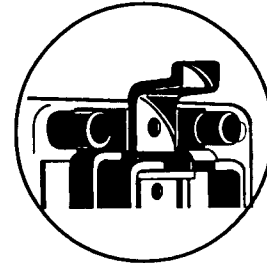

NOTE: Rubber capped feet on the mounting plate prevent the pump from sliding when placed on a counter top or isolette.

C. ATTACHING AND REMOVING THE PUMP FROM THE POLE CLAMP ASSEMBLY

To attach the pump to the Pole Clamp Assembly, slide the Mounting Plate down into the grooves on the assembly until the Release Latch locks into place.

The pump may be quickly and easily removed from the assembly by gently pulling back on the Release Latch and sliding the pump up and out of the grooves.

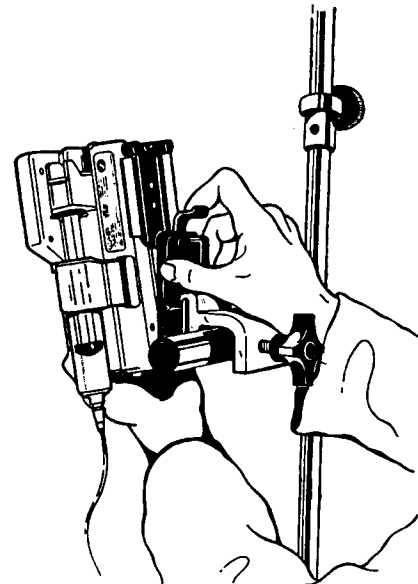

D. ROTATING THE PUMP ON THE POLE CLAMP

When attached to the Pole Clamp Assembly, the pump can be rotated to better suit its environment. To rotate the pump, grasp it firmly and turn it in the desired direction. You feel the pump stop and lock into four different positions: Straight Up, 90 degrees to the right, Upside Down and 90 degrees to the left.

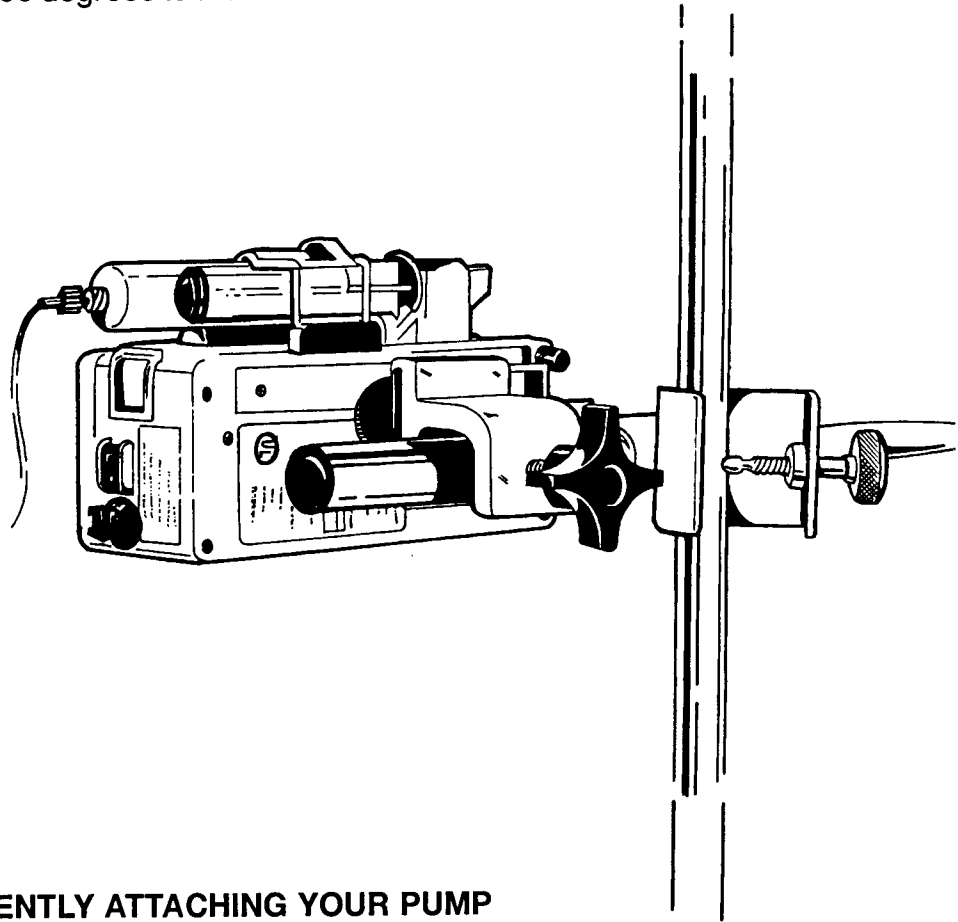

E. PERMANENTLY ATTACHING YOUR PUMP TO THE POLE CLAMP

To permanently affix the pump to the Pole Clamp Assembly, slide the Mounting Plate into the assembly, then attach the entire unit to the pump with flat head screws (Consult Technical Services at manufacturer for further information).

ADDITIONAL ACCESSORIES:

Also available from Medex is a "T" bar multiple pump pole mount pictured below. In addition to multiplying the capacity of one I.V. pole for the multiple pumps, it allows orientation of the pump for easy visualization.

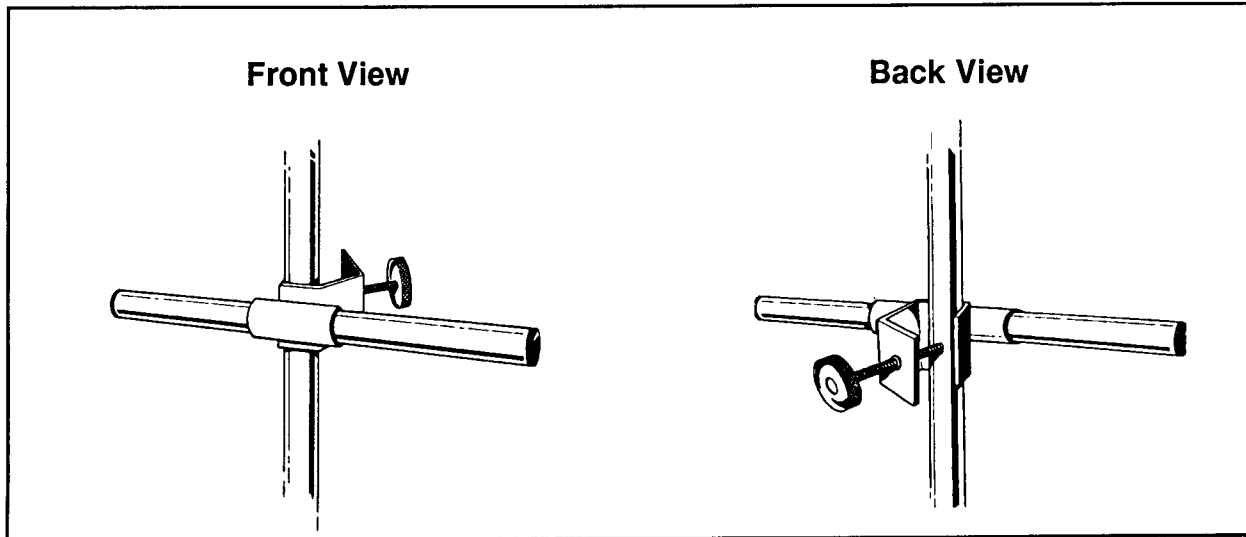
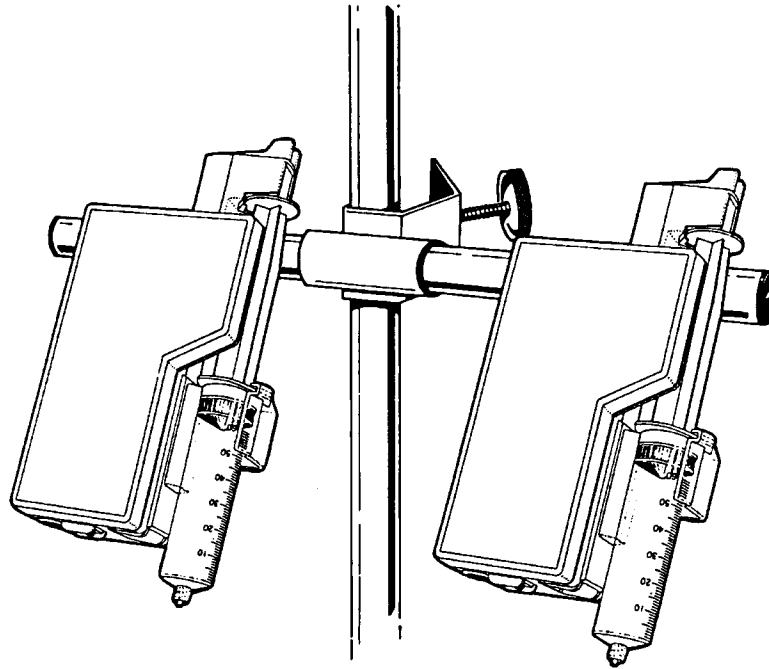

SECTION 14: Precautions



WARNING:

1. This pump is for use only under the direction of qualified medical professionals.
2. Verify all programmed settings PRIOR to initiating delivery.
3. Verify that both the manufacturer of the syringe in use and the syringe size coincide with the information displayed on LCD display.
4. Purge all air from the syringe and infusion lines BEFORE connecting to patient.
5. Do not place any labels on the syringe that will be covered by the syringe retainer clamp. This clamp must contact the syringe barrel without interference to ensure accurate syringe size sensing.
6. Do not use in presence of flammable anesthetics or explosive gases (i.e. in laboratories or in operating rooms where explosive gases are present).
7. The PRIME function should always be utilized when mounting a newly filled syringe to remove any mechanical slack. Failure to do so may delay the delivery of the infusate and cause the TOTAL VOLUME DELIVERED display to read higher than actually delivered to the patient.
8. Manufacturer recommends use of syringes as indicated in the General Specifications Section. Contact manufacturer for use of other syringes.
9. If the pump fails to perform as described herein, remove from service and consult the manufacturer.
10. Deletion of Type 1 and 2 alarms silences the audio component for the following alarm conditions: STOP/PROGRAM [type 1] (includes standby mode), NEAR EMPTY [type 2], EMPTY [type 2] and VOLUME LIMIT[type 2].
11. When an occlusion occurs and is corrected, there is a risk of infusing the pressurized build up of Infusate. To avoid inadvertent bolus, relieve the pressure before restarting the infusion.
12. If "yes" is selected in the query for use of the B-D® Luer Lock 1cc syringe in custom programming, the operator must select the appropriate syringe size (i.e., 1cc or 3cc). The pump cannot distinguish between these syringe sizes. Failure to select the correct syringe size will result in inaccurate delivery. Always confirm that the syringe size stated on the LCD agrees with the size of the syringe loaded on the pump.
13. If the pump has been dropped or damaged, it must be thoroughly examined and tested to assure that it is functioning properly. Failure to do so could result in either under or over delivery of medication along with the resulting consequences.
14. Do not expose the pump to strong magnetic fields as it may affect pump function.

15. It is recommended that this pump not be used in situations where the syringe is connected to a system much lower than atmospheric pressure (i.e., negative pressure below -100mmHg). At certain pressures, the plunger could be pulled from the retainer resulting in a siphoning situation and the resulting complications of an overdelivery, which could include serious injury or death.



CAUTION:

1. Always verify carefully that the syringe is mounted properly. The finger tabs should be secured by the syringe clamp and the syringe plunger end by the syringe driver retainer.
2. Do not allow fluids to enter the pump. Immediately wipe off all spills.
3. The TOTAL VOLUME DELIVERED and the VOLUME LIMIT use separate counters.
4. Do not use organic solvents to clean the pump. Use only those agents listed under "cleaning" to clean and disinfect the pump. Use of unapproved agents may damage the pump. (*See cleaning agent section*).
5. Do not autoclave or subject the pump to temperatures which exceed 50 degrees C.
6. Use only those drugs which are compatible with the disposable syringe selected and the existing environmental conditions.
7. Verify that the model number and software version of the pump and the instruction manual agree.
8. In the VOLUME/TIME mode, the pump may be programmed to deliver as little as 0.05 ml, however, the calculated rate must be greater than or equal to the minimum allowable rate for that particular size of syringe.
9. In consideration of how syringe pumps operate, clinicians should consider use of appropriate syringe, tubing, and in-line devices for the given application and the drug being infused. Certain factors enhance multiple characteristics of syringe pump infusion such as time to detect an occlusion, visual verification of volume delivered, continuity of flow, time to reach the set rate. Following are considerations requiring discretion by clinicians using syringe pumps. (Typically, this is most important with continuous injections of short half-life drugs.)
 - a. Select the smallest syringe size appropriate for the intended application. Friction within the syringe (between the plunger rubber tip and the barrel) can affect the continuity of flow and the time required to attain the set infusion rate; the plunger tip expands and relaxes throughout the infusion, particularly with larger syringes at slower rates. The best case is to use smaller syringes at higher rates.
 - b. Do not use a 60 cc syringe for rates of 2.0 cc/hour or less. Such use is generally not recommended by syringe manufacturers when using a syringe pump.

- c. Connect the syringe pump tubing at the closest point to the patient for more predictable and accurate delivery of the fluid.
 - d. Use small internal diameter, high hardness tubing and no in-line devices for best results at low rates.
10. A routine preventive maintenance schedule should be followed according to the policy defined by the individual hospital. Presently, Medex recommends that these procedures be performed as recommended in the Service Manual. Additional routine cleaning and inspections should be performed on an as needed basis (i.e., droppage, fluid contamination, suspect malfunction, etc.).



IMPORTANT:

On the front of this manual is a revision date. If the date is over three (3) years, please contact manufacturer to see if additional information related to this product is available.

SECTION 15: Cleaning

The pump housing may be cleaned with the following agents:

AMMONIA and 97% water
CLOROX and 90% to 95% water
CONTROL III (by Maril Products, Inc.)
COLD SPOR (by Metrex Research Corporation)
DETACHOL (by Fernadale Laboratories, Inc.)
ENVY (by S. C. Johnson & Son, Inc.)
ENZOL (by Johnson & Johnson Medical, Inc.)
ETHYL ALCOHOL 95% (190 proof)
HARCO TINCTURE OF GREEN SOAP (by Harley Chemicals)
ISOPROPYL ALCOHOL 70% (rubbing alcohol)
ISOPROPYL ALCOHOL 70% and 10% ACETONE

LpH, se (by Calgon Vestal Laboratories)
MANU-KLENZ (by Calgon Vestal Laboratories)
METRI ZYME (by Metrex Research Corporation)
MILD SOAP AND WATER SOLUTION
NUTRA-pH (by Snowden-Pencer)
SANI-CLOTH (by distributor: Professional Disposables, Inc.)
SEPTISOL (by Calgon Vestal Laboratories)
SPORICIDIN (Sporicidin, International)
TOR-II (by Huntington Laboratories, Inc.)
WISK ADHESIVE REMOVER PAD (by Baxter Healthcare Corporation)

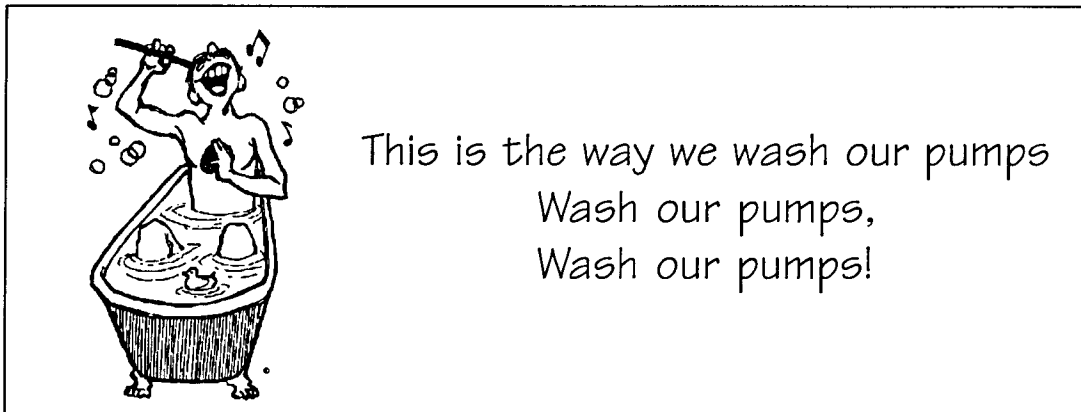

CAUTION:

Recommendations for agents applies to compatibility of agent with the plastic housing and is not based on the cleansing/disinfecting ability or effectiveness. Medex makes no representations as to any agent's ability to cleanse or disinfect. We defer to the guidelines of the manufacturer for mixing instructions for agents listed.



WARNING:

Do not use solutions containing strong detergents, organic solvents, quaternary ammonium or ammonium chloride to clean any portion of the pump, as serious damage could result. **DO NOT IMMERSE.** Avoid spills and inadvertent allowance of fluid in the pump housing.

SECTION 17: Custom Program Mode

The Custom Program Mode (CP) allows customization by the selection of the infusion mode(s), the bolus (yes or no), the alarm volume, the alarm temporary delay time, alarm types and syringe manufacturer. Entry into this mode is limited due to the lockout feature. This mode generally is utilized by healthcare professionals and biomedical engineering to initially preprogram the pump prior to routine clinical use. Once the pumps is programmed in the Custom Program Mode, go to Sections 4 and 5 for normal operating instructions.

STEP 1: ENTERING THE CUSTOM PROGRAM (CP) MODE

STEP 1A: ENTER CP MODE

To enter the CP Mode, press and hold down at the same time the SELECT and ENTER keys then turn the pump on with the power switch. Hold SELECT and ENTER until an audible peck occurs. The LCD display should be blank.



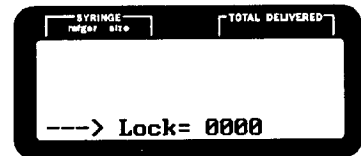

Release the SELECT and ENTER keys to visualize the LOCK CODE.

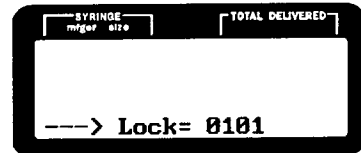

STEP 1B: ENTER LOCKOUT ACCESS CODE

Program the access code 0101 by using the appropriate RATE SELECTION KEY(S).



NOTE: Simply press twice  and  once.

NOTE: An inadvertent misentry may be corrected by pressing any two RATE SELECTION KEY(S) simultaneously which converts the display to zeroes.

Press ENTER to confirm the code. The pump will automatically advance to the CP Mode if a valid code is entered.



An erroneous code denies access to the CP Mode.

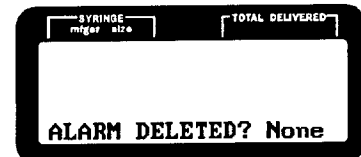

STEP 2: ALARM DELETE

Use the SELECT key to choose #1, #1 and #2, or none (See Section 10: Alarms/Alerts).



Press ENTER to confirm the alarms to be deleted.



SECTION 17: CUSTOM PROGRAM MODE CONTINUED...

STEP 3: ALARM VOLUME
Use the SELECT key to toggle between soft and loud. Press the ENTER key to confirm selection.

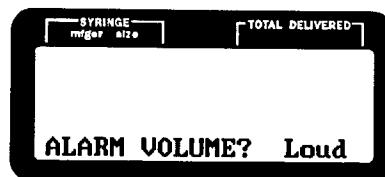

STEP 4: ALARM DELAY
Use the SELECT key to toggle between 2 min and 60 min. Press the ENTER key to confirm selection.

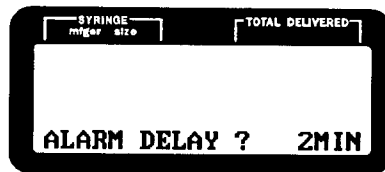

STEP 5: NEAR EMPTY
Press the RATE SELECTION KEY(S) to select time between 5 and 60 min.

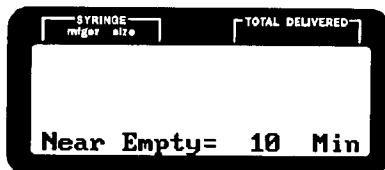

NOTE: *An invalid setting causes time to default to an acceptable number. Press ENTER to confirm selection.*

STEP 6: SELECT MANUFACTURER
Use the SELECT key to delete syringe manufacturer.

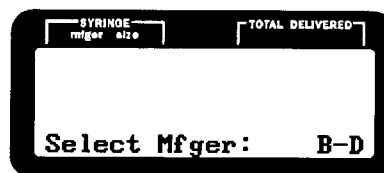

Use the ENTER key to accept syringe manufacturer.

STEP 7: B-D® LUER LOCK SYRINGE
(only if B-D® is selected as manufacturer)
Press the SELECT key to toggle between "yes" or "no". Press the ENTER key to accept syringe brand.

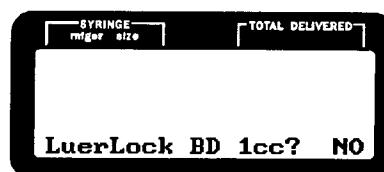

STEP 8: SELECTION OF MODES
Press the SELECT key to delete mode. Press ENTER key to accept mode. An asterisk indicates this mode has been selected. Press the PROTOCOL key to move from screen #1 to #2. When modes have been chosen on Screen #2, press the PROTOCOL key to move to bolus delivery.

Screen #1

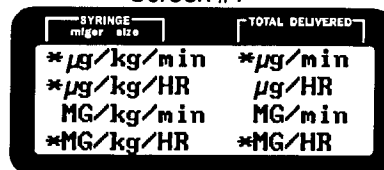

Screen #2

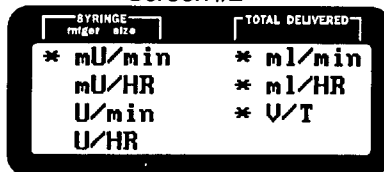

NOTE: *Once Screen #2 is selected you may not return to Screen #1.*

SECTION 17: CUSTOM PROGRAM MODE CONTINUED..

STEP 9: BOLUS DELIVERY

Press the SELECT key to toggle between "yes" and "no". Press ENTER key to confirm selection.



NOTE: *This will allow for bolus delivery in all modes except Volume/Time.*

STEP 10: VOLUME LIMIT

Press the SELECT key to toggle between "yes" and "no". Press the ENTER key to confirm selection.

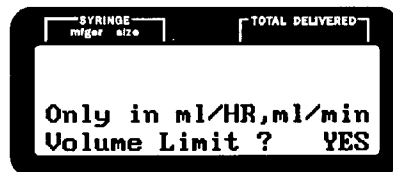

NOTE: *Volume limit is only available in ml/min and ml/HR.*

STEP 11: ENABLE LOCK



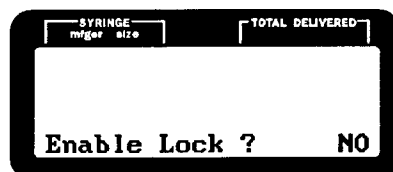

Press the SELECT key to toggle between "yes" and "no". Press the ENTER key to confirm selection.

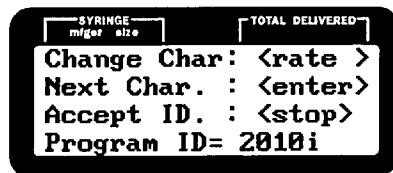

STEP 12: PROGRAM PUMP ID

Choose up to 8 characters which will be displayed on initial power-up in upper right hand corner of the LCD.



Press the RATE SELECTION KEY(S)     to choose letters and/or characters. Press ENTER to confirm each character and move to the next selection. An I.D. may be 1-8 characters. When I.D. is complete, press STOP/PROGRAM key to accept. The pump will then leave the Custom Program Mode and proceed to the infusion mode.

SECTION 18: User Banks

User Banks Introduction

The User Bank allows the user to store information from all modes except volume over time. Information may include: Concentration, Weight, Bolus, Rate, ID (User Name) and Volume Limit. Information that cannot be stored includes: Total Delivered, Syringe Size and Syringe Manufacturer.

The User Bank is divided into two user banks "A" and "b". Each user bank is capable of storing up to 32 sets of names, characters, numbers, etc. Access to user bank "b" occurs any time the pump is turned on. Access to User Bank "A" requires accessing a special field prior to each power up. Programming information in either "A" or "b" is the same.

NOTE: Once a program is entered in the Bank, the *DECIMAL SHIFT* is no longer active.

STEP 1: ACCESS TO DATA BANK "b"

STEP 1A: Enter a mode and program all variables that are to be saved.

NOTE: If any variables are still flashing access to user bank will be denied.

STEP 1B: Press and hold STOP/PROGRAM key and then press PROTOCOL.

STEP 1C: Fourth line of LCD with flash alternately: "Save to Data Bank "b" - Press enter"

Press ENTER.

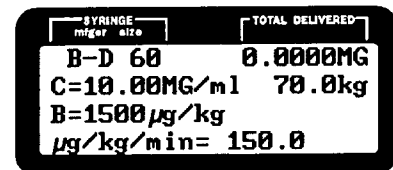

Hold Down

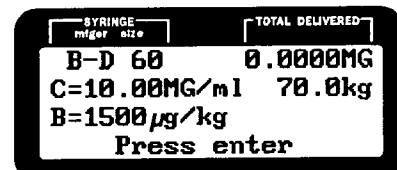
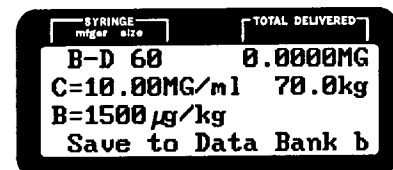

STEP 2: CHOOSING USER NUMBER

STEP 2A: Press the SELECT key to move cursor to user number selected.

Press ENTER to confirm.

NOTE: Pressing the PROTOCOL key changes the screen which displays user numbers (4 screens)

User b01 - User b08 (Screen 1)
 User b09 - User b16 (Screen 2)
 User b17 - User b24 (Screen 3)
 User b25 - User b32 (Screen 4)

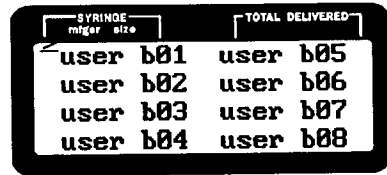

STEP 3: CHOOSING USER NAME

STEP 3A: Press the PRIME key to clear user b01 from screen.

STEP 3B: Press the RATE keys to change letters and/or characters.

⬆️ ⬇️ - Move letters rapidly.

⬆️ ⬇️ - Move letters slowly.

To confirm each letter, press ENTER. The programming line moves to the next space.

NOTE: The first character in Data Bank b will always be a lower case letter. Each subsequent character is a lower case letter, character or space.

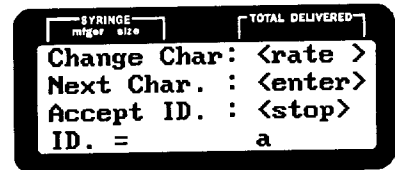
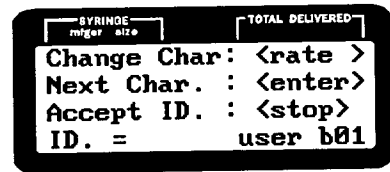

STEP 3C: ACCEPTING ID

When all characters have been entered, press the STOP key to accept the ID.

The screen will return to the programmed mode and the name will be displayed on the third line of the LCD.

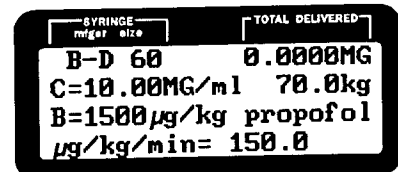
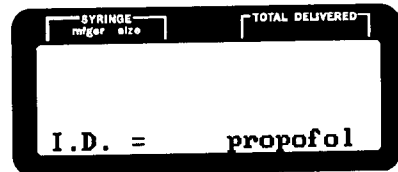

STEP 4: PROGRAMMING ANOTHER USER

STEP 4A: Press the PROTOCOL key until mode screen appears.



STEP 4B: Program all variables then follow instructions beginning with STEP 1B through 3C (*not shown*).

STEP 5: ACCESSING SAVED NAME

Press the PROTOCOL key until the saved name appears on screen. Press the SELECT key until cursor is next to name, then press ENTER to confirm.

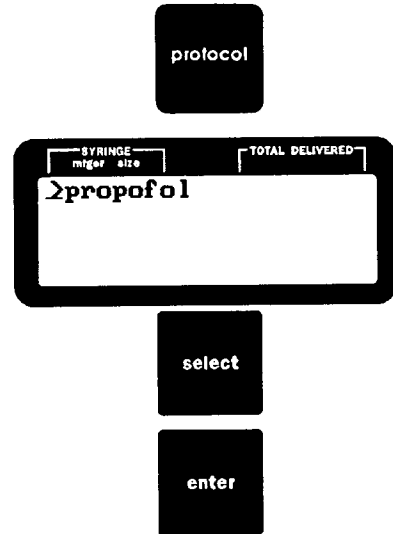

STEP 6: PROGRAM USER NAME

Follow normal steps for programming (*See Section 5 and 6*).

OR

If this is not the name desired, press the PROTOCOL key to go back to the previous screen.

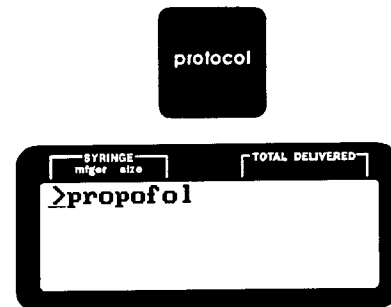

STEP 7: USER BANK A

STEP 7A: ACCESS TO USER BANK A

NOTE: Access to User Bank A is limited. Prior to turning pump on, press and hold down **PROTOCOL** key. Continue holding this key while turning the pump on. An audio peck confirms entry into User Bank A.



The bottom line of LCD appears as shown.

STEP 7B: Program 1.50 with the RATE SELECTION KEY(S) .
(Pressing 3 times will program proper number).



STEP 7C: Press ENTER to confirm entry.



The pump now goes through normal power up sequence.

STEP 7D: Access the desired mode and program all the variables to be saved.

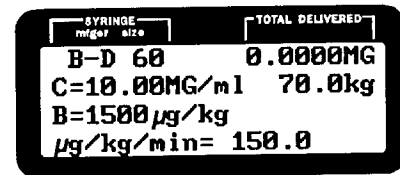

STEP 7E: Press and hold STOP/PROGRAM key and then press PROTOCOL to save the information to Data Bank A.



STEP 7F: Fourth line of LCD will flash alternately: "Save to Data Bank b - Press enter".

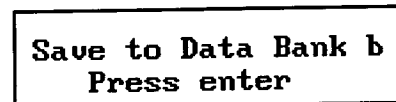

STEP 7G: To save to Data Bank A, press the PROTOCOL key until message reads: "Save to Data Bank A - Press enter".

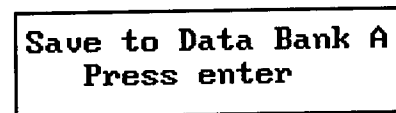

Press ENTER.



STEP 8: CHOOSING USER NUMBER

STEP 8A: Press the SELECT key to move cursor to user number selected.

STEP 8B: Press ENTER to confirm.

NOTE: Pressing *PROTOCOL* key will change screens which display user numbers (4 screens).

USER A01 - USER A08 Screen 1
 USER A09 - USER A16 Screen 2
 USER A17 - USER A24 Screen 3
 USER A25 - USER A32 Screen 4

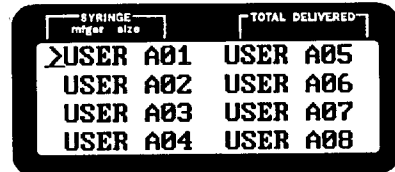

STEP 9: CHOOSING USER NAME

STEP 9A: Press the PRIME key to clear USER A01 from screen.

STEP 9B: Press the RATE keys to change letters and/or characters.

- Move letters rapidly.
 - Move letters slowly.

To accept each letter, press ENTER. The programming line will move to the next space. If a character is incorrectly accepted, continue to press the ENTER key until the cursor returns to the character desired.

NOTE: The first character in User Bank A will always be an upper case letter. Each subsequent character is an upper case letter, character or space.

STEP 9C: ACCEPTING ID

When all characters have been entered, press the STOP key to accept the ID. The screen returns to the programmed mode and the name displays on the third line of the LCD.

STEP 10: PROGRAMMING ANOTHER USER

STEP 10A: Press the PROTOCOL key until the infusion mode screen appears.

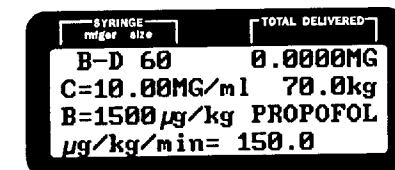
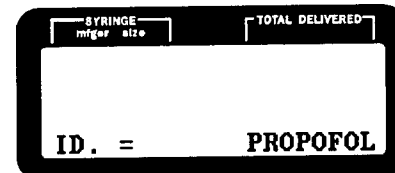
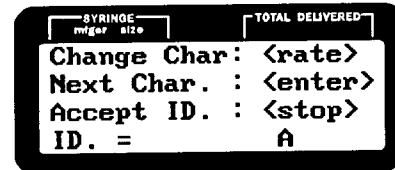
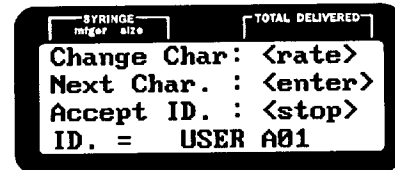

STEP 10B: Program all variables then follow instructions beginning with Step 7E through Step 9C (*not shown*).



STEP 11: ACCESSING SAVED NAME

Press the PROTOCOL key until name appears on screen. Press the SELECT key until cursor is next to name, then press ENTER to confirm.

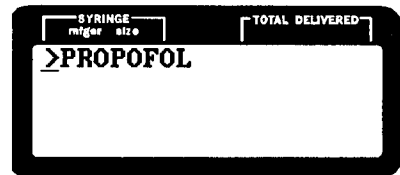

STEP 12: PROGRAM USER NAME

Follow normal steps for programming (*See Sections 5 and 6*).



OR

If this is not the name desired, press the PROTOCOL key to go back to the previous screen.

DELETING A PREPROGRAMMED USER NAME

STEP 1A: Using the PROTOCOL key find user name on LCD.



NOTE: *If name is to be deleted from User Bank A, follow steps 7A to 7C to access User Bank A.*

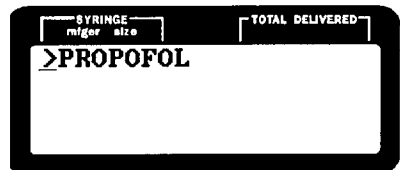

STEP 1B: Use the SELECT key to choose name to be deleted.



STEP 1C: Press ENTER to confirm.



SECTION 18: USER BANKS CONTINUED...

STEP 2: Confirm information by pressing ENTER for each variable.

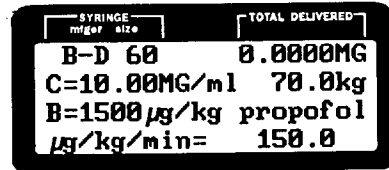

NOTE: A syringe must be loaded to delete a name.

STEP 3: ACCESSING USER BANK

STEP 3A: Press and hold STOP/PROGRAM and then press the PROTOCOL key. The bottom line of the LCD will alternately display "Send to Data Bank b - Press enter".

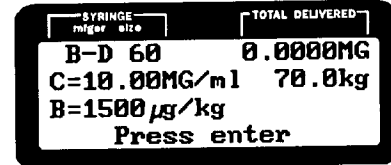
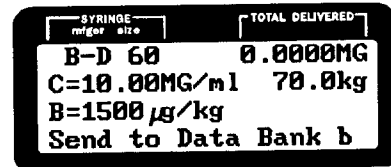

STEP 3B: Press the SELECT key. The LCD now reads alternately "Delete from Data Bank - Press enter".



Press ENTER.

All information is now present except the name is gone and has been removed from data bank.

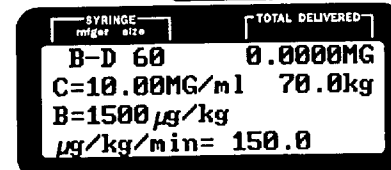
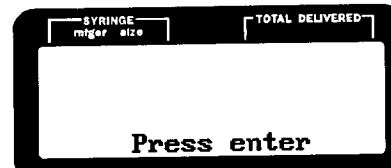
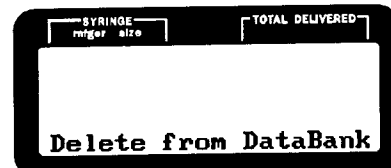

USER PROGRAMMING

STEP 1: Accessing User Name

STEP 1A: Turn pump on and select the syringe manufacturer. Press ENTER.

STEP 1B: If the pump has been previously programmed, the screen shows either the last mode or name programmed.

STEP 1C: If the current ID is satisfactory, proceed to Step 1F. If not, press PROTOCOL to find name or mode desired. Continued pressing of PROTOCOL reviews all names and modes available.

STEP 1D: Choosing the name from screen. Press SELECT key to choose desired name.

STEP 1E: Press ENTER to confirm.

STEP 1F: The LCD now alternately flashes, "Load Syringe - Press ENTER".

If the syringe is not already loaded onto the pump, load per instructions (See Syringe Loading, Section 4).

Follow all previous steps for programming.

NOTE: *If information is already correct, simply press ENTER to continue programming.*

NOTE: *Decimal point movement is not allowed in User Bank "A" or "b".*

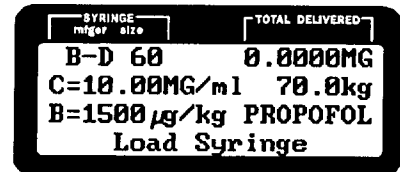
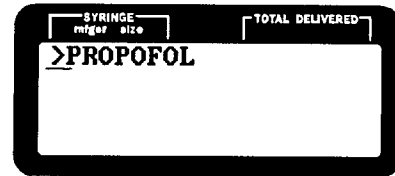
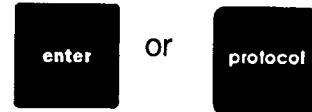
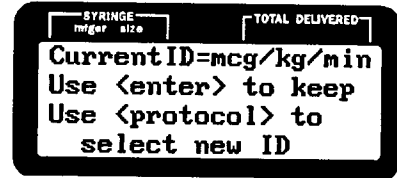

APPENDIX I : FLOW RATES

<u>MANUFACTURER</u>	<u>SYRINGE SIZE</u>	<u>ML PER HR</u> (In Tenths)	
		<u>Maximum</u>	<u>Minimum</u>
Abot.....	50.0	360.0	0.1
B-D.....	1.0	11.00	0.01
B-D.....	3.0	36.00	0.01
B-D.....	5.0	70.00	0.01
B-D.....	10.0	104.0	0.1
B-D.....	20.0	182.0	0.1
B-D.....	30.0	234.0	0.1
B-D.....	60.0	355.0	0.1
BD-G.....	1.0	10.00	0.01
BD-G.....	3.0*	36.90	0.01
BD-G.....	5.0	70.00	0.01
BD-G.....	10.0	104.0	0.1
Mono.....	1.0	11.00	0.01
Mono.....	3.0	39.60	0.01
Mono.....	6.0	80.80	0.01
Mono.....	12.0	126.0	0.1
Mono.....	20.0	207.0	0.1
Mono.....	35.0	285.0	0.1
Mono.....	60.0	356.0	0.1
Teru.....	1.0	11.00	0.01
Teru.....	3.0	39.60	0.01
Teru.....	5.0	80.80	0.01
Teru.....	10.0	126.0	0.1
Teru.....	20.0	207.0	0.1
Teru.....	30.0	270.0	0.1
Teru.....	60.0	378.0	0.1

**A 2.5 ml B-D® glass syringe is recognized in the software as a 3 ml syringe; therefore, 3 ml is the selection option for a 2.5 ml B-D® glass syringe.*

NOTE: *Depending on the location of the decimal point, rates can be programmed in smaller increments (e.g.: 0.01, 0.001, .0001 provided the minimum rate is exceeded. For example, if the decimal point is placed in the hundredths location on a 12cc MONO syringe the minimum rate is 00.10. Once the minimum has been satisfied the operator can program a number in the hundredths place (e.g.: 00.15).*

APPENDIX 2: DEFINITIONS

Alarm Temporary Delay Time:

A custom programmed delay time of either 2 or 60 minutes that is activated when the alarm key is pressed once.

Alarm Volume:

A program option in the CP mode that allows variance of the alarm auditory volume as either loud or soft.

Body Weight Mode:

A level of pump operation that delivers either mcg or mg per kilo per time (e.g.: minute or hour).

Bolus:

A level of pump operation during which a preprogrammed amount is delivered at the fastest rate possible for the syringe size in use, by pressing the BOLUS key and then the DELIVER key.

Continuous Mode:

A level of pump operation that allows delivery of a specific fluid volume at a specified rate. (Useful in delivery of a volume of medication at a specific constant rate.)

Custom Program Mode (CP):

A level of pump operation that is limited in access by a lockout feature and generally only accessed by healthcare professionals or biomedical engineers to preprogram or customize the pump by selection of the infusion modes, the alarm volume, the alarm temporary delay time, alarm types and bolus option.

Delivery Mode:

The level of pump operation during which the infusion occurs as initiated by pressing the DELIVER key and indicated by the blinking of the green LED DELIVER key light.

Delivery Time (DT):

Time in hours and minutes for the dose volume to be delivered.

Dose Volume (DV):

Volume (in mls) of dose to be administered (the same as volume limit in the volume/time mode).

I.D.:

A parameter of 8 characters utilized by the owner to identify the pump. It may be the unit name, hospital name, individual name, location, department, etc.

Infusion Modes:

Used to refer to Mass Mode, Body Weight Mode, Continuous Mode and Volume Over Time Mode.

Invalid Number:

A LCD parameter that indicates what has been programmed is not consistent with other values entered. An entry that is programmable will be displayed.

Light Emitting Diode (LED):

A red, yellow or green light function signalled by the pump.

Liquid Crystal Display (LCD):

The pump screen.

Mass Mode:

A level of pump operation that delivers $\mu\text{g}/\text{min}$, $\mu\text{g}/\text{HR}$, MG/min , MG/HR , milliunits/ min , milliunits/ HR , units/ min , units/ HR .

Prime:

A level of pump operation that is only activated in the program mode when all other functions have been entered. Priming allows the fluid to be delivered to replace air in the tubing attached to the syringe. The actual priming volume can be verified on the prime volume counter of the LCD. The prime function also eliminates any mechanical slack whenever a syringe is loaded in the pump.

Running Volume (RV):

A recording of total volume delivered since the last dose volume reset. The Dose Volume minus running volume equals the volume yet to be delivered.

Standby Time:

The time (in hours/minutes) on the LCD display during the standby mode that represents the time remaining before the timer equals zero.

Total Delivered:

Refers to the amount of medication actually delivered during the course of an infusion (however, does not include the volume delivered in the priming mode).

User Banks:

A level of pump programming which allows the user to create custom delivery regimen in two user banks. Each user bank allows storage of up to 32 regimens.

Volume Limit:

Volume (in mls) of dose to be administered in the ml/min or ml/HR mode.

Volume/Time Mode:

A level of pump operation that delivers a specific dose volume over a specified delivery time (useful in delivery of a single dose over a specific time).

APPENDIX 3: Use of the B-D® Luer Lock Syringe

If B-D® Luer Lock 1cc syringes are utilized with the Medfusion 2010i Syringe Pump the option for this selection must be made in custom programming as follows:

Custom Program Mode:

The LCD queries the use of the B-D® Luer Lock 1cc syringe after programming operations are chosen.

The SELECT key toggles between YES and NO.

Press ENTER to confirm choice.



WARNING:

If the B-D® Luer Lock Option was selected in Custom Programming, the operator must select the appropriate syringe size (i.e., 1cc or 3cc). The pump cannot distinguish between these syringe sizes. Failure to select the correct syringe size will result in inaccurate delivery. Always confirm that the syringe size stated on the LCD agrees with the size of the syringe loaded on the pump. The pump cannot automatically identify syringe manufacturer.

Operating Mode:

The LCD only queries the use of the B-D Luer Lock 1 cc syringe if it is custom programmed and if a 3 cc or 1 cc Luer Lock syringe is loaded.

The SELECT key toggles between 3 cc and L1 (Luer Lock 1 cc).

Press ENTER to confirm choice.

Continue programming for delivery once selection is made.

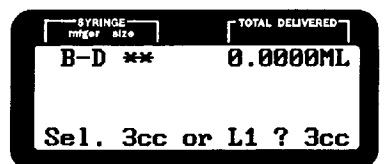
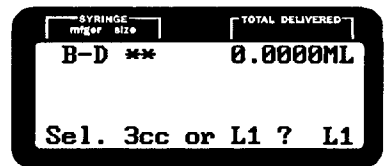
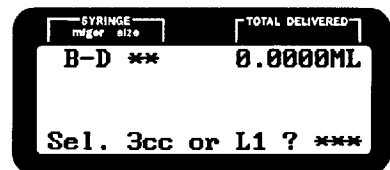
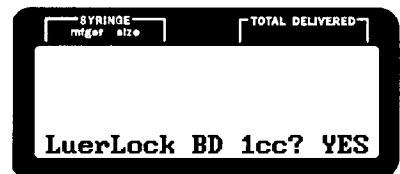
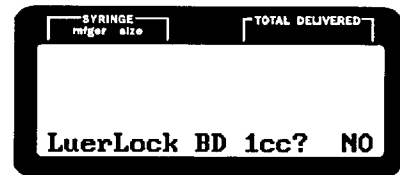

APPENDIX 4: LOCKOUT

The Lockout key prevents the user from making changes to the pump. It will allow starting and stopping only.

To Lock:

1. Lock must have been enabled in Custom Program Mode.
2. Press the lock key  after all information has been entered or during delivery. A lock symbol appears on the first line of the LCD display.

To Unlock:

1. Press lock key  during stop or delivery and the lock symbol disappears from the LCD.

Alarm Condition:

All alarms which cause the pump to stop infusing (e.g.: empty, syringe pops out, check clutch, occlusion, etc.) release the lock automatically. After the alarm has been cleared, the lock may be re-enabled.

APPENDIX 5: PUMP I.D.

Each pump may have its own I.D. This can be accomplished in custom programming and is seen on the first line of the LCD during power-up. (See Appendix 2 for definition).